

**Instruction Manual  
EZ-Thump V2  
Portable Fault Locating System  
(1.5/3kV Dual , 4 kV and 12 kV Models)  
New Version 2**

Read this entire manual before operating.

**Megger**®

Valley Forge Corporate Center  
2621 Van Buren Avenue  
Norristown, PA 19403-2329  
U.S.A.

610-676-8500

*[www.megger.com](http://www.megger.com)*



**Portable Fault Locating System  
EZ-Thump V2  
1.5/3kV Dual, 4 kV and 12 kV Models  
Instruction Manual for New Version 2 (V2)**





The information presented in this manual is believed to be adequate for the intended use of the product. If the product or its individual instruments are used for purposes other than those specified herein, confirmation of their validity and suitability must be obtained from Megger. Refer to the warranty information below. Specifications are subject to change without notice.

## WARRANTY

Products supplied by Megger are warranted against defects in material and workmanship for a period of one year following shipment. Our liability is specifically limited to replacing or repairing, at our option, defective equipment. Equipment returned for repair must be shipped prepaid and insured. Contact your local MEGGER representative for instructions and a return authorization (RA) number. Please indicate all pertinent information, including problem symptoms. Also specify the serial number and the catalog number of the unit. This warranty does not include batteries, lamps or other expendable items, where the original manufacturer's warranty shall apply. We make no other warranty. The warranty is void in the event of abuse (failure to follow recommended operating procedures) or failure by the customer to perform specific maintenance as indicated in this manual.





<b>Local Megger Offices</b>		
<b>Australia</b> Megger Pty Limited Unit 1, 11-21 Underwood Road Homebush NSW 2140 T: +61 (0)2 9397 5900 F: +61 (0)2 9397 5911	<b>Canada</b> 110 Milner Avenue Unit 1 Scarborough Ontario M1S 3R2 Canada T: 1 416 298 6770 F: 416 298 0848 Canada.Sales@megger.com	<b>France</b> 23 rue Eugène Henaff ZA du Buisson de la Couldre 78190 TRAPPES T: 01 30 16 08 90 F: 01 34 61 23 77
<b>Germany</b> SebaKMT Dr. Herbert Iann Str. 6 96148 Baunach / Germany T: +49 9544 680 F: +49 9544 2171 MeggerSales@sebakmt.com	<b>India</b> Megger (India) Pvt Limited 501 Crystal Paradise Mall Off. Veera Desai Road Andheri (W) Mumbai 400053 T: +91 22 26740468 F: +91 22 26740465	<b>Kingdom of Bahrain</b> P.O. Box 15777 Office 81, Building 298 Road 3306, Block 333 Manama Kingdom of Bahrain. T: +973 177 40 620 F: + 973 177 20 975 mesales@megger.com
<b>Kingdom of Saudi Arabia</b> PO Box 1168 Khobar 31952  T: +966 3889 4407 F: +966 3889 4077 mesales@megger.com	<b>South Africa</b> PO Box 22300 Glen Ashley 4022 Durban South Africa  T: +27 (031) 5646578 F: +27 (031) 5637990	<b>Sweden</b> Megger Sweden AB Eldarvägen 4 Box 2970 SE-187 29 TÄBY SWEDEN T: +46 8 510 195 00 F: +46 8 510 195 95
<b>Switzerland</b> Megger Schweiz AG Ob. Haselweg 630 5727 Oberkulm, Aargau  T: +41 62 768 20 30 F: +41 62 768 20 33	<b>United Kingdom (Dover)</b> Megger Limited Archcliffe Road Dover CT17 9EN  T: 01304 502101 F: 01304 207342	
<b>United States (Dallas)</b> 4271 Bronze Way, Dallas, Texas 75237-1019 USA  T: 1-800-723-2861 F: 1-214-331-7399	<b>United States (Valley Forge)</b> Valley Forge Corporate Centre 2621 Van Buren Avenue Norristown, PA 19403 USA T: 610 676 8500 F: 610-676-8610	<b>United States (College Station)</b> 4064 State Highway 6 South College Station, TX 77845 USA T: 979-690-7925 F: 979-690-0276

# Table of Contents

1	SAFETY.....	1
	Precautions .....	1
	Warning and Caution Notices .....	1
	Working with Equipment .....	1
	Operating Staff .....	2
	Repair and Maintenance .....	2
	General Cautions and Warnings .....	2
	Intended application .....	2
	What to do if equipment malfunctions .....	2
	Five safety rules.....	3
2	TECHNICAL DESCRIPTION .....	5
	System Description - V2 Models .....	5
	Power Options.....	7
	Features.....	8
	Scope of Delivery .....	9
	Accessories .....	9
	Technical Data.....	9
	Control Elements, Indicators and Connectors .....	11
3	SETTING UP THE SYSTEM.....	13
	Connection diagram.....	14
	Connection Sequence .....	14
4	OPERATING INSTRUCTIONS.....	15
	Basics of Operation.....	15
	Operation with rotary knob.....	15
	High Voltage Control .....	16
	Safety Circuit.....	17
	Introduction .....	17
	Conditions of the Safety Circuit.....	17
	External Remote Safety Device (must be ordered separately) .....	17
5	SYSTEM SETTINGS.....	19
	Default Settings .....	19
	Measurement Parameters and TDR Features .....	21
	Advanced Features.....	24
6	CABLE TESTING METHODS .....	25
	DC HV Breakdown Test / DC HIPOT Test.....	25
	Introduction .....	25
	Procedure.....	25
	Sheath Test  / Phase to Ground Test  .....	26
	Introduction .....	28
	Connection Diagram (Sheath Test and LV Fault Locating) .....	28
	Procedure.....	28

---

---

7 CABLE FAULT PRELOCATING METHODS.....	30
Sectionalizing -  (optional, special software required).....	30
Introduction.....	30
Procedure .....	31
Pre-Location (Locate)  .....	32
Introduction.....	32
Procedure .....	33
8 CABLE FAULT PINPOINTING.....	34
Thumping -  .....	34
Introduction.....	34
Procedure .....	34
Sheath Fault Pinpointing -  (optional) LV Fault Pinpointing (unshielded cables).....	35
Introduction.....	35
Connections.....	36
Procedure .....	36
9 COMPLETION OF OPERATION .....	38
Switching Off.....	38
Disconnecting the Test Object .....	38
10 MAINTENANCE .....	40
Storage .....	40
APPENDIX 1 .....	42
“Help Menu” to Configure TDR Features in "Quick Steps" and "Expert Mode" Menus.....	42
SELECTION TABLE (Mark with X) to document users selected TDR features.....	43
APPENDIX 2 .....	45
Special Customized - Permanently Mounted Wheel Kit.....	45

## Receiving Instructions

### ***UPON RECEIPT OF YOUR DELIVERY***

Prior to operation, check for loosened hardware or damage incurred during transit. If these conditions are found, a safety hazard is likely, **DO NOT** attempt to operate equipment.

Please contact Megger as soon as possible.

Please check your delivery against:

- a) your order
- b) our advice note
- c) the item delivered, and
- d) the parts list

**any shortages must be reported immediately.**

**Megger.**



# 1

## SAFETY

### *Precautions*

This manual contains basic instructions on commissioning and operating the EZ- Thump V2 system. For this reason, it is important to ensure that the manual is available at all times to authorised and trained personnel. Any personnel who will be using the devices should read the manual thoroughly. The manufacturer will not be held liable for any injury or damage to personnel or property through failure to observe the safety precautions contained in this handbook.

Locally applying regulations have to be observed.

### *Warning and Caution Notices*

Warning and caution notices are used throughout this manual where applicable. These notices appear in the format shown below and are defined as follows:



#### **WARNING!**

Warning, as used in this manual, is defined as a condition or practice which could result in personal injury or loss of life.



#### **CAUTION**

Caution, as used in this manual, is defined as a condition or practice which could result in damage to or destruction of the equipment or apparatus under test.

*NOTE: The notes contain important information and useful tips for using the system. Failure to observe them can render the measuring results useless.*

### *Working with Equipment*

It is important to observe the general electrical regulations of the country in which the device will be installed and operated, as well as the current national accident prevention regulations and internal company rules (work, operating and safety regulations).

After working with the equipment, make sure to de-energize, protect against re-energizing, discharge, ground and short-circuit the instrument and installations that have been worked on.

Use genuine accessories to ensure system safety and reliable operation. The use of other parts is not permitted and invalidates the warranty.

## ***Operating Staff***

This system and its peripheral equipment may only be operated by trained or instructed personnel. Anyone else must be kept away.

## ***Repair and Maintenance***

Repairs and service must only be done by Megger or authorized service departments of Megger. Megger recommends having the equipment serviced and checked once per year at a Megger service location.

Megger also offers direct on-site support. Please contact our service office for more information.



### **WARNING**

**Except for the battery there are no user serviceable parts inside!**  
**Refer all servicing to the factory or a qualified authorized service company!**

## ***General Cautions and Warnings***

### **Intended application**

Safe operation can only be guaranteed if using the equipment for its intended purpose. Using the equipment for other purposes may endanger the safety of the personnel operating the equipment as well as damage or destroy it.

The safe performance limitations described in the technical data section must be observed. Operating High Voltage equipment in environments with high humidity, incl. condensation may lead to dangerous flash-over conditions and must be avoided. It is not permissible to operate high voltage equipment, which is in direct contact with humidity, water or is located near aggressive chemicals or explosive gases and fumes.

### **What to do if equipment malfunctions**

The equipment shall only be used if working properly. If irregularities or malfunctions appear that cannot be resolved by consulting this manual, the equipment must immediately be turned off and marked as not functional. In this case the HDW service should be contacted to resolve the problem. The instrument may only be put in operation again after the malfunction has been corrected.

---

### **Five safety rules**

- The five safety rules must always be followed when working with HV (High Voltage):
- De-energize
- Protect against re-energizing
- Confirm absence of voltage
- Ground and short-circuit
- Cover close by energized components



#### **Cardiac Pacemaker**

Personnel with Cardiac Pacemakers shall not operate any high voltage equipment!



#### **Fire fighting in electrical installations**

- According to regulations, Carbon Dioxide (CO<sub>2</sub>) is the only permissible agent to extinguish fires in electrical installations.
- Carbon dioxide is electrically non conductive and does not leave any residue. It is safe to be used in energized facilities as long as the minimum distances are maintained. A CO<sub>2</sub> fire extinguisher must be always available within electrical installations.
- If, contrary to the regulations, any other extinguishing agent is used for fire fighting, this may damage the electrical installation or equipment. HDW is not responsible for any consequential damage. When using a powder extinguisher near high-voltage installations, the danger exists that the operator of the fire extinguisher will get an electrical shock from a voltage arc-over (due to the powder, which causes a dust explosion).
- It is essential to observe the applicable safety instruction for the extinguishing agent.



#### **WARNING - Dangers when working with HV**

Special attention and safety awareness are mandatory when operating HV equipment and especially portable equipment. The OSHA regulations (USA) and VDE 0104 (Europe) about setting up and operation of electric test equipment, i.e. the corresponding EN 50191(Europe) as well as country and company-specific regulations and standards must be observed.

- The system generates a potentially dangerous voltage of up to 4/12 kV during operation, which is applied to the test object.
- *The system shall not be operated without supervision.*
- *Safety installations and procedures shall not be by-passed nor deactivated.*
- *All metallic parts in close proximity of the test equipment must be grounded in order to avoid the build-up of hazardous electric surface charges.*

**Megger.**

# 2

## TECHNICAL DESCRIPTION

### ***System Description - V2 Models***

The EZ-Thump V2 (Version 2) is a compact and light weight, battery or AC operated fault location system for low voltage and medium voltage cables, which along with the still available 4 and 12kV units is now also offered as a dual stage 1.5/3kV unit, with 500J in each of the stages. In addition, all EZ-Thump V2 feature:

1. Relocated internal 24V battery, which can be exchanged by the customer
2. New internal battery charger, which allows operation from either the internal battery or from the AC line voltage while simultaneously charging the battery.
3. F-Ohm safety circuit, checking that proper grounding is provided.
4. Output contact for an optional external remote Emergency Off module
5. Lid mounted cable pouch to accept the HV and ground cables as well smaller accessories, while reducing the footprint of the EZ-Thump V2 at the same time
6. Optional permanently mounted wheel kit (availability will be announced later)\* *\*See photo of preliminary prototype in Appendix 2*

**The 12kV unit** is ideally suited for use in a "satellite" fault location concept for out-laying areas with a lesser fault frequency, when speed, simple operation, weight and economics are the driving factors for fault locating of medium – or distribution type cables. **The 1.5/3k and 4kV units** are well suited for fault locating on various types of low voltage cables of different construction, e.g. Street Light Systems, LV Underground Circuits in the utility industry and industrial plants.

What sets all the EZ-THUMP V2 models apart from other so called smart and intuitive GUIs, regardless what voltage model is used, is the unique and distinct feature common to all E-TRAY based units, including the EZ-THUMP V2, that it will "pull" the user through the typical fault locating procedure in its entirety and acts like an expert system. The first step is a DC Breakdown test to determine the flashover voltage of the fault, followed by ARM prelocation in

order to obtain an approximate distance to the fault, followed by the exact pinpointing of the fault in order to repair it. The entire process proceeds automatically without any required adjustments from the user, only prompting the user to "authorize" to apply HV at the various steps of the procedure for safety reasons.

After each individual step of the procedure the software will gather its relevant results and offer in certain situations an interpretation of the fault situation after the entire process is finished.

This unique feature of the E-TRAY software will support the user in his or her decision making regarding "difficult" faults. At any time during the process the user can stop the automatic sequence (manual override) and continue to operate the unit totally independently.

Independent of the voltage range the EZ-TUMP provides the following methods to perform and or assist cable fault locating (low and medium voltage cables of various designs up to a 25kV system rating):

TESTING: Timed DC HV Hipot, DC HV Breakdown, Sheath Test

PRELOCATING TDR, Arc Reflection

PINPOINTING: Surge Generator (Flashover Fault),  
Earth Gradient Method (Ground Fault)

Besides the proven prelocation technique (inductive ARM), the EZ-Thump V2 provides acoustic or magnetic/acoustic pinpointing with the integrated 500 J surge generator, as well as HV DC for breakdown detection, HV DC insulation proof testing, sheath testing and sheath fault locating, which in its identical form can be also used for fault locating of faults in unshielded LV cables.

## Product Models

The EZ-Thump V2 is available as a:

- 1.5/3kV dual stage unit 500J version
- 4 kV version 500J
- 12 kV version 500J

All models carry the V2 designation in their model names to distinguish from the previous model and highlighting the new features as described in section entitled *System Description - V2 Models*.

This manual covers all models of the EZ-Thump V2. If necessary, the differences are noted in the text.

## Power Options

The EZ-THUMP V2 can be operated from either an internal 24V NiMH (5AH) battery or from AC line voltage (120/230V), which aside from operating the unit will also charge the battery simultaneously. A fully charged battery will typically last between 30 and 60 minutes continuous thump operation at room temperature depending on its age. Temperatures near freezing will reduce the usable battery life.

When plugged in to the AC line power, the status of the *charger* is displayed by a LED, changing its color as explained on the decal below the AC receptacle on the front side of the unit, please see the following illustration.

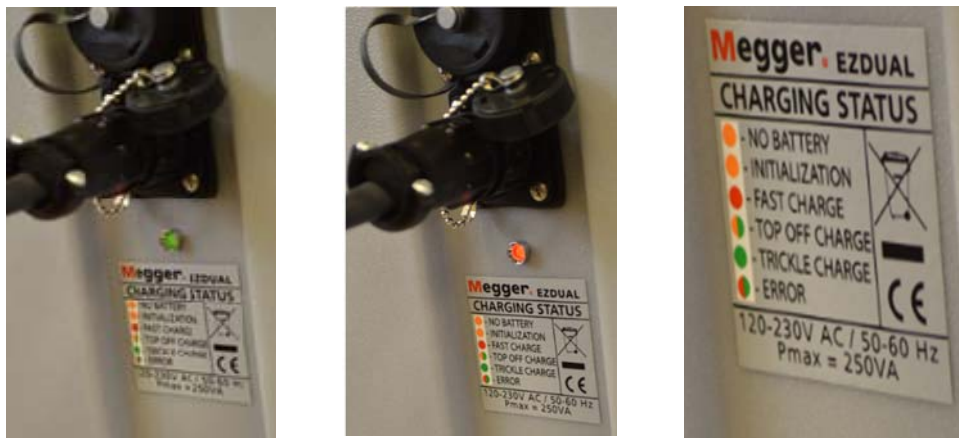

*LED Indicator for charger (Not Battery) when connected to AC power line*

When the EZ-Thump V2 is switched on and operated from the internal battery, the *charging condition of the battery* is indicated by the colored bar graph icon, which is located in the upper right hand corner of the display.

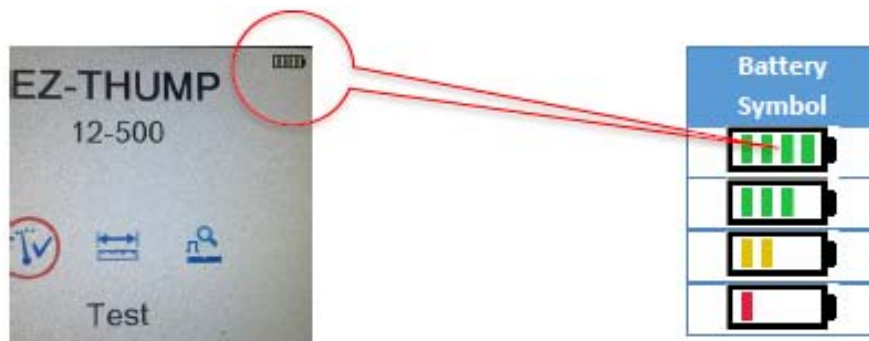

A fully charged battery shows 4 green bars. After approximately 25 minutes of constant thumping it will be reduced to 3 green bars. After an additional 10 minutes, 2 yellow bars will appear. After another additional 10 minutes the single

red bar will be visible. The times given are approximate values. The best indication of the true capacity of the battery is when looking at the voltage recovery during the thump operation. The highest energy draw is experienced at the end of the full charging cycle of the capacitor. Initially, it is expected that the battery might lose the 4<sup>th</sup> bar at the end of the capacitor charging cycle, but when finished, it should always recover to the 4 bar state. The 25 minutes mentioned above means that after 25 minutes the voltage will not recover any more to the 4 bar status, but remains at 3 bars and will show the same behavior as described above for the 4 bar, and so on.

## Features

The EZ-Thump V2 system is unique in its class of competitive units and combines the following features and functions in a single device:

- **Quick-Steps and Expert modes**, with regard to a list of 20 TDR features, which can be selected individually by the customer and made available in either of the 2 menus. This feature allows addressing different skill levels amongst the users of the unit by granting 2 levels of access rights.

Typically in **Quick Steps** only the most basic features are made available, because many users are not familiar with the specifics of the TDR and additional features would create more confusion than benefit. The idea is that he or she performs basic *fault locating* without any adjustments required, and allowing access only to very basic adjustments, if needed.

Conversely in the **Expert Mode** basically all TDR features are made available, assuming the expert user can make good use of the features to also difficult faults in more difficult situations.

- Automatic detection and localization of transformers (optional)
- Automatic fault prelocation and localization with regard to the 2 closest transformers (Sectionalizing, optional) in typical North American loop feed URD circuits (optional).
- Automatic cable end and fault detection
- DC breakdown test up to 3/4/12 kV
- DC Hipot Test (timed) up to 3/4/12kV with insulation resistance indication
- Sheath test with automatic breakdown detection (optional, no charge)
- Sheath / LV unshielded cable fault pinpointing (optional, no charge)
- Hi-Brite 5.7" Color TFT Display



- Operation from internal battery or from AC source
- Sturdy enclosure and weatherproof for outdoor use (IP53)

### Scope of Delivery

The scope of delivery of the EZ-Thump V2 system comprises the following components:

- AC power cord: 8ft (2.4M)
- HV Output Cable 12ft (3.5m)
- Owner’s manual: AVTMEZT
- Safety Ground Cable: 12ft (3.5m)

### Accessories

Typical North American accessories available from Megger , other accessories are available (see separate Data Sheet Accessories, with 14 or 10 mm MC connectivity).

Accessories	Description	Item number
Elbow adaptor with 14 mm female MC connector	Used to connect HV output cable to transformer bushing	865000100100000 (15 kV)
		865000200100000 (25 kV)
		865000300100000 (35 kV)
External remote safety device (optional)	Used in situations where operator has to step away from the unit (e.g. manhole)	P/Ns 893024147 and 890024896 Order separately

### Technical Data

The EZ-Thump V2 system is defined by the following technical parameters:

Parameter	Value
<b>Test voltage</b>	0-1.5/ 0-3kVDC; 0 to 4kVDC; 0 to 12 kV DC
<b>Surge voltage</b>	0-1.5/0-3kV; 0 to 4kV; 0 to 12kV
<b>Source current</b>	94 and 47mA (1.5/3kV version) 35mA (4kV version) 14 mA (12 kV version)

Parameter	Value
Surge energy	500 J at 1.5/3; 4; 12kV maximum surge voltage in each cap range
Power supply	120 V / 230 V $\pm$ 15%, 50 / 60 Hz
Battery	integrated NiMH battery (24 V / 5 Ah)
Operating time battery	>30 min (pinpointing)
Display	640 x 480 pixel Hi Brite TFT, direct sunlight readable
Memory	>1000 traces
Interfaces	USB port
Measuring range	25,000 ft. (8km)
Measuring resolution	2.5 ft. at 250 ft/ $\mu$ s (0,8 m at 80 m/ $\mu$ s)
Max. sampling rate	100 MHz
Update rate	5 samples / second
Dynamic range	64 db
Output impedance	64 $\Omega$
Operating temperature	-4 °F to 122 °F (-20 °C ... +50 °C)
Storage temperature	-12 °F to 160 °F (-25 °C ... +70 °C)
Dimensions (W x H x D)	14" x 11" x 21" (355 x 280 x 533 mm)
Weight	4 and 12kV = 71 lbs (32 kg) 1.5/3kV = 75 lbs (34 kg)
Protection class (in accordance with IEC 61140)	I
Protection rating (in accordance with IEC 60529)	IP53 (rain water proof)

## Control Elements, Indicators and Connectors

The EZ-Thump V2 has the following control elements, indicators and connectors:

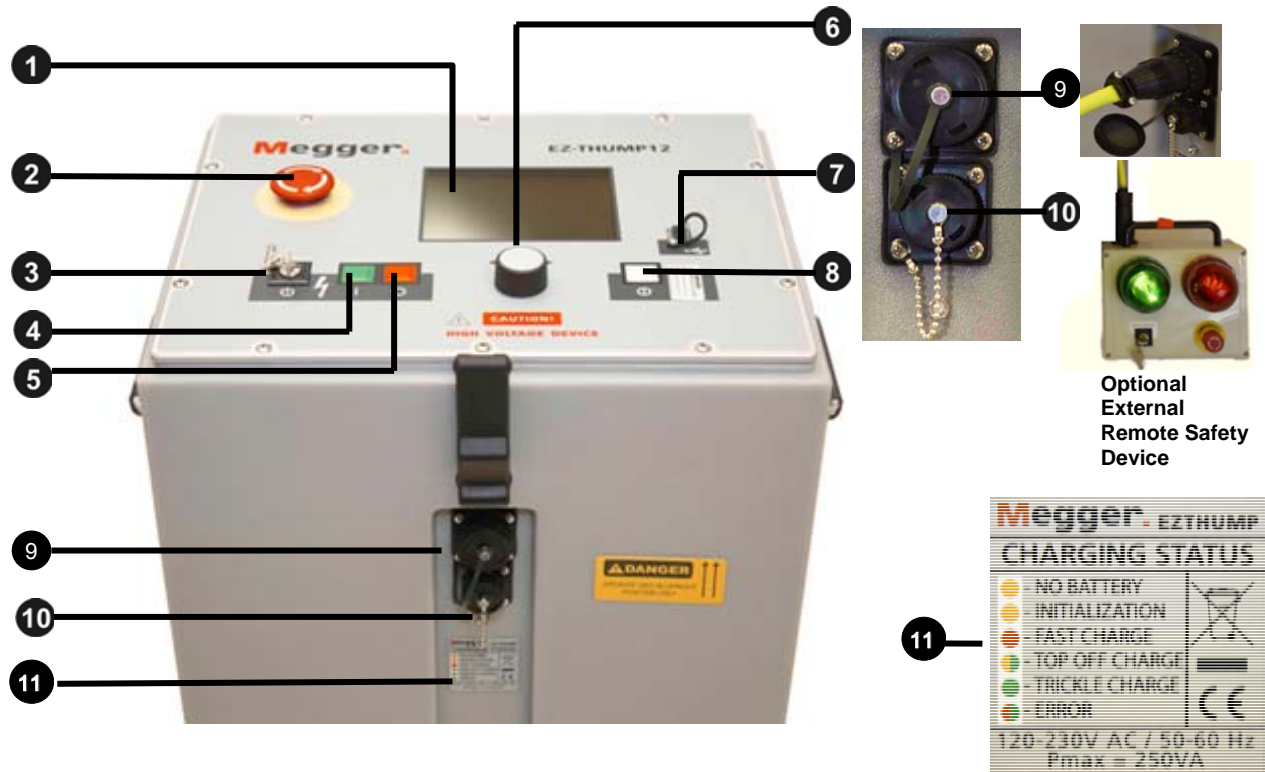

Element	Description
1	Display
2	Emergency OFF button
3	HV "Interlock" Key Switch
4	"HV ON" Button
5	"HV OFF" Button
6	Rotary Knob
7	"ON / OFF" Button
8	USB Slot
9	Connector interface for external remote safety device (optional: P/Ns 893024147 and 890024896 order separately)
10	AC power connector and battery charger LED indicator
11	Legend detailing status of internal battery <b>charger</b>

**Megger.**

# 3

## SETTING UP THE SYSTEM



### **WARNING - Safety instructions for setting up**

- Always follow the safety instructions on page 317 - in particular the five safety rules - before connecting the unit to the cable to be tested.
- Before connecting the system to the cable to be tested, be sure that the cable has been discharged / isolated and tested in compliance with all National / Federal, State and & company safety procedures.
- Select a location to set up the unit which is sufficient for the weight and size of the system and ensures that it is stable. Always locate the system off to the side of the cable path and the closest transformer, never on top of the cable path.
- When setting up the unit, ensure that it does not impair the function of any other systems or components. If other systems and components have to be modified in order to set up and operate the unit be sure to reverse these actions when the work is finished. Always take in account any special requirements for these systems and components before carrying out any work and only after consulting and obtaining approval from whoever is in charge of them.
- Cordon off the test site and block access to the danger zone and prevent the risk of touching live parts.
- Always operate the EZ-Thump V2 in a vertical position. Ground and HV contacts both require a vertical orientation to ensure proper functioning as well as a "Fail Safe Position" in case of an AC or DC power failure or if the unit is shut off.
- After obtaining clearance to the test object, make sure that no dangerous voltage can reach unprotected places or other equipment.
- As a matter of principle, all de-energized cables, which are not part of the test shall be shorted and grounded.

## Connection diagram

The following figure shows the connection diagram.

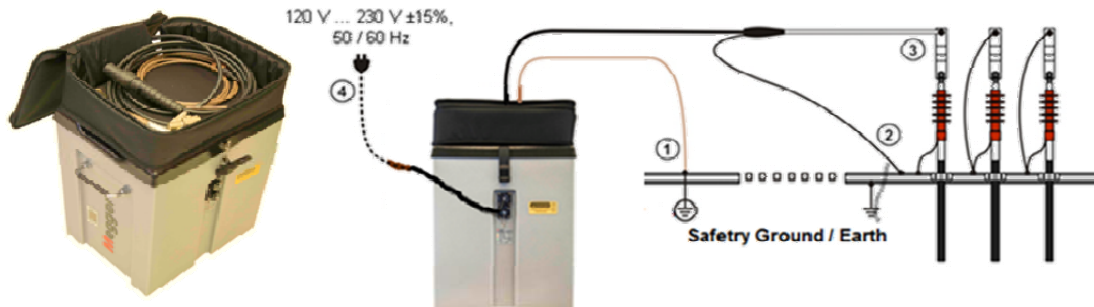

## Connection Sequence

Connect the unit in the following order:

Step	Description
①	<b>Connect the safety ground lead</b> to a good system ground.
②	<p><b>Connect the HV return lead</b> to the cable shield or the concentric neutral of the specific cable to be tested. The resistance between the HV return (operational ground) and safety ground should be less than 5 <math>\Omega</math> (check with ohmmeter). If the resistance is greater than 5 <math>\Omega</math>, an additional ground cable should be connected from the concentric directly to the system ground rod. If not, the F-OHM safety module will activate and prevent the user from switching HV on. If HV was already active when a resistance increase in the safety loop was experienced, it will shut HV off, and will automatically discharge and ground the unit.</p> <div style="border: 1px solid black; padding: 10px; margin-top: 10px;"> <p><i>NOTE: The HV return must be connected to or as close as possible to the concentric neutral of the cable to be tested, right next to the “break-away” point.</i></p> <p><i>The Safety Ground must be connected to, or as close as possible, to the ground rod of the switchgear or transformer.</i></p> </div>
③	<b>Connect the HV test lead</b> to the phase conductor to be tested (optional elbow adapter or vise-grip – see page 9.)
④	<p><b>Connect the supplied power cord</b> to the connector <b>10</b> on the front of the unit and connect the other end to a power outlet, if the unit is to be operated from AC line voltage <b>or</b> the battery of the unit requires charging.</p> <div style="border: 1px solid black; padding: 10px; margin-top: 10px;"> <p><i>NOTE: If no power connection can be established, the unit is automatically operated from internal battery.</i></p> </div>

# 4

## OPERATING INSTRUCTIONS

After start-up, the system is in the 'Ready for operation' state and the main menu is displayed (shown for the 12kV/500J version, in one of the various configurable set-ups).



Whenever one particular test mode has been selected (red circle), the high voltage source *remains switched off and* the high voltage output is shorted to ground via a discharge resistor, *until the operator activates the green HV ON button.*

### ***Basics of Operation***

#### **Operation with rotary knob**

Navigation within the available menu items is accomplished using the rotary knob **6** as follows:

**Turning**⇒**Selecting**⇒**Pressing**⇒ **Confirming** ("ENTER" function)

The actual selected menu item is identified by a red circle.



**not selected**



**selected**

With the aid of the rotary knob, the individual menu items can be accessed and if applicable, values can be selected by turning the rotary knob. Once a menu item with a selectable parameter is chosen, the following dialog box is displayed:



The value for the parameter can then be adjusted by turning the rotary knob clockwise or counter clockwise and, confirmed by a short click on the rotary knob. If only one arrow is available (up or down), it means that the selected parameter is either at its lowest or highest set point and can only be adjusted in the opposite direction.

## High Voltage Control

Before starting the test, the user is prompted to enable high voltage. To do so, the green illuminated "HV ON" button **4** must be pushed within a 10 sec time window, otherwise the HV readiness has to be re-initiated (safety interlock).

Pushing HV ON lifts the closed contact at the discharge resistor and powers up the high voltage power supply, without raising the HV. The red illuminated "HV OFF" button **5** signals that, without additional steps, the EZ-Thump V2 will provide HV at its output as soon as the HV has been adjusted (typical North American mode).

For other parts of the world the EZ-Thump V2 can be programmed to require an additional step before HV can actually be released (see default settings). With the red HV-OFF illuminating, the green HV-ON will extinguish. In order for the red HV-OFF to come on, the conditions of all safety circuits must be satisfied. They are described in section "*Safety Circuits*" below.

The high voltage, in any of the available modes, can be switched off at any time during the test via the red "HV OFF" button **5**, or if warranted by the Emergency OFF button. Regardless of how high voltage was shut off, the high voltage power supply is turned off and the HV output is discharged and grounded and the green HV-ON light will illuminate.



## Safety Circuit

### Introduction

Upon turning high voltage on, the system's safety circuit continuously checks all safety-relevant parameters and switching operations of the system. Should the safety circuit detect a change in any of the monitored safety parameters *while in high voltage mode*, the system automatically switches high voltage off and the HV output is discharged and grounded. The reason for the shut off is shown on the display and must be acknowledged /eliminated before any HV operation and or testing can be activated gain.

### Conditions of the Safety Circuit

The following conditions must be fulfilled in order to perform tests under high voltage:

- The HV key switch **3** must be in the  $\odot$  position.
- The emergency off button **2** must be in the *up and released* position
- The loop resistance in the F-Ohm safety circuit must be below 5 Ohms.

### External Remote Safety Device (must be ordered separately)

If the operator cannot remain in the immediate area where the EZ-Thump V2 is located, he can take the optional external remote safety module with him. This set-up allows him push the *Emergency Off* button from wherever he or she is and does not require him or her to go back to the unit to operate the *Emergency Off* button (e.g. operator in manhole).



**Megger.**

# 5

## SYSTEM SETTINGS

### Default Settings

In order to select the *default and system settings*, the **expert settings** have to be accessed *from the main menu*. Once in the **expert settings** the scroll down menu provides the following options:

Menu option	Description	
	In order <i>to gain or re-gain</i> access to the <b>expert mode</b> , the rotary knob must be held down in the main menu (on any of the icons) until the system prompts for the password, which is required to activate the expert mode. The default password is "0000".	
<b>Leave expert mode</b>	Leaving the expert settings by activating this command from the top of the scroll down menu ensures (that any changes in the settings are saved and the expert mode is disabled. The cogwheel (  ) is no longer displayed on the main menu screen. This prevents unauthorized persons from changing the system settings, provided they are not privileged to the password.	
<b>Date / Time</b>	Date and time settings	
<b>Language</b>	Language settings	
<b>Default setting</b>	Opens a measurement settings submenu with the following menu options:	
	<b>Measurement unit</b>	
	<b>Length</b>	Unit of the x- axis when in TDR / LOCATE modes ( <b>Meter, Feet or Time</b> ). If set to <b>Time</b> , the actual pulse runtime is displayed and no conversion is performed at all.
	<b>Rate</b>	<u>Only available, if Length is set to <b>Meter or Feet</b></u> The way the velocity of propagation of the pulse within the cable is specified. This can be done either relative to the speed of light ( <b>NVP</b> ) or absolute in ' $\mu$ s'(μsec).
	<b>V/2 or NVP</b>	<u>Only available, if Length is set to <b>Meter or Feet</b></u> Velocity of propagation of the cable under test (see Rate setting above) E.g. a NVP value of 0,650 corresponds to 65% of



Menu option	Description
	the speed of light.
<b>Trigger delay time</b>	<p>Waiting time in the ARM mode between the trigger signal (beginning of the breakdown) and the start of the TDR fault trace measurement. The delay time allows the flash-over to build up well before a reflection measurement is done.</p> <p><i>If Delay time is too short:</i> Flash-over is not continuous and reflection may not be clear or not visible at all, the fault trace cannot be captured</p> <p><i>If Delay time is too long:</i> Flash-over is already extinguished before reflection can occur. Thus fault trace cannot be captured and looks identical to reference trace.</p> <p>Trigger delay Default Setting to 0.7msec = 700µsec</p>
<b>Measurement start</b>	<p>The way a measurement is started:</p> <p><b>Automatic: typical in N. America</b>  <b>Manual: typical in other parts of the world.</b></p>
<b>Set-up Start Marker</b>	<p>Procedure to adjust the start marker to the actual end of the connection cable, so any measurement on the tested cable does not include the length of the test leads.</p> <p>First the operator is asked to open the connection leads (HV and HV Return), whereupon a pulse reflection measurement is taken. After the gain setting has been adjusted and confirmed, a copy of the trace is frozen.</p> <p>This is followed by a prompt to shorten the connection leads. A second trace recorded immediately thereafter and should show a significant separation (split point). The marker is automatically placed at the position where both traces start separating.</p> <p>If required, the marker can be manually adjusted.</p> <p>Afterwards the <b>new setting must be acknowledged</b> in order to save it as the new default.</p> <div style="border: 1px solid black; padding: 5px; margin-top: 10px;"> <p><i>Note: Repeat the process <b>only if</b> for whatever reason the length of the test lead is changed (i.e. connection to a cable reel).</i></p> </div>
<b>Backlight settings</b>	Backlight timeout and contrast settings
<b>Time Out Settings</b>	Minutes of inactivity after which the system is automatically shut down.
<b>Stored Traces</b>	Menu option to export or delete all traces which have been stored in the internal memory
<b>System</b>	Advanced system information, showing factory set configuration,







Menu option	Description
<b>configuration</b>	software version, serial number (cannot be changed by customer).
<b>Change password</b>	Menu option to change the password required to enable access to the expert mode. This is <b>not recommended</b> without documenting the new password.
<b>Return</b>	By leaving the expert mode through this menu item, the new settings are saved.



## Measurement Parameters and TDR Features

In the following chapter the relevance of 19 parameters pertaining to the operation of the TDR function are described. The availability of these parameters can be individually programmed by the customer in each of the 2 available menus, QUICK STEPS and EXPERT MODE, please see Appendix 2

As soon as at least one trace is shown in the display the TDR features can be accessed via the  icon. This menu contains the following menu options:

Menu option	Description
 <b>Adjust Gain</b>	<p>Adjusts the gain setting. By doing so, the amplification of the received signal and, thus, the amplitude of the Y-axis can be adjusted.</p> <p>With an adjustment of the gain setting, the fault trace, if present, is erased and a new “live” trace is immediately recorded.</p> <div style="border: 1px solid black; padding: 5px; margin-top: 10px;"> <p><i>NOTE: Typically the unit will adjust the gain automatically. If manual adjustments are made, make sure to keep the gain at a fairly low level during arc reflection fault locating procedures; at higher gains the fault might become non recognizable!</i></p> </div>
 <b>Change visible range</b>	<p>Changes the displayed range. By doing so, the visible range can be adjusted between approximately 100 ft (30 m) and 25,000 ft (7.5 km) ( the highest zoom window of 100 ft or 30 m can be applied continuously along the maximum visible range of 25,000 ft or 7.5 km.</p>
 <b>Change NVP value</b>	<p>Allows manual adjustment of the velocity of propagation. By doing so the conversion of the distance values (X-axis scaling) are directly influenced (5% increase = 5% increase in length).</p> <p>This menu option is only effective, if the Rate parameter is set to <b>Meter</b> or <b>Feet</b> (see page 19 <i>Default Settings</i>).</p> <p>You may either manually adjust the value or automatically adopt the value by selecting a cable from the cable list.</p>

Menu option	Description
 <p><b>Set / Move Cursor</b></p>	<p>Changes the cursor position. By doing so, the distance value for any point on the trace can be obtained. The cursor can be scrolled along the X-axis, if the display range should be either decreased or increased.</p> <p>At first, a coarse adjustment is made and confirmed by pressing the rotary knob <b>6</b> once. Subsequently, the position can be fine-tuned.</p>
 <p><b>Adjust the End Marker</b></p>	<p>Allows the manual adjustment of the blue end marker, if the automatic adjustment appears not be satisfactory.</p> <p>At first, a coarse adjustment is made and confirmed by pressing the rotary knob <b>6</b> once. Subsequently, the position can be fine-tuned.</p>
 <p><b>Put Trace on Hold</b></p>	<p>Makes an exact copy (blue trace) of the “live” trace.</p> <div style="border: 1px solid black; padding: 10px; margin-top: 10px;"> <p><i>NOTE: This function is especially useful, if you want to verify the position of a transformer on the trace by temporary grounding the cable at the transformer. You are then able to locate the position where the “live” trace and the frozen copy start drifting apart. This is the exact transformer position.</i></p> <p><i>This feature is also very helpful when comparing <b>pairs of phases</b> in LV cables to identify the faulted phase</i></p> </div>
 <p><b>Set additional Marker at Current Cursor Position</b></p>	<p>Places an additional marker at the cursor position (see above). As only one additional marker can be placed, the very last marker is erased every time the marker is placed on a new position.</p>
 <p><b>Save Current Trace</b></p>	<p>Saves the current LV trace to the internal memory, must be initiated from feature icon.</p> <div style="border: 1px solid black; padding: 5px; margin-top: 10px;"> <p><i>NOTE: The unit automatically saves the combination of LV and HV trace , typical arc reflection trace</i></p> </div>
 <p><b>Change transformer sensitivity</b></p>	<p>Allows manual adjustment of the transformer search sensitivity. Decreasing the sensitivity forces the algorithm to recalculate the number of identified transformer positions (attenuation effect). It will not effect the position of the transformers which are not effected by the chance in sensitivity</p> <p>The sensitivity setting can be changed in order to determine the most realistic transformer mapping.</p>

Menu option	Description						
<p style="text-align: center;">●</p> <p><b>Export, Recall or Delete Stored Traces</b></p>	<p>Enables to export, recall and delete stored traces from internal memory.</p> <p>First, a date needs be to selected, which allows scrolling through all traces which have been stored on this day.</p> <p>Selecting a trace by pressing the rotary knob <b>6</b>, the following options are available:</p> <table border="1" data-bbox="708 499 1461 978"> <tr> <td data-bbox="708 499 911 716"><b>Export</b></td> <td data-bbox="911 499 1461 716">Will copy the selected trace to the <i>EtrayTraces</i> folder on the USB flash drive which has already been plugged into the USB slot <b>8</b>. The traces can be displayed in any regular web browser by opening the index.html file which is also located in the <i>EtrayTraces</i> folder.</td> </tr> <tr> <td data-bbox="708 716 911 793"><b>Remove</b></td> <td data-bbox="911 716 1461 793">Removes the selected trace from internal memory.</td> </tr> <tr> <td data-bbox="708 793 911 978"><b>Recall</b></td> <td data-bbox="911 793 1461 978">Loads and displays the selected trace on the screen, which can be manipulated by almost any of the functions described in this table  By selecting <b>X</b>, the loaded trace is closed and the last recorded trace is displayed again.</td> </tr> </table>	<b>Export</b>	Will copy the selected trace to the <i>EtrayTraces</i> folder on the USB flash drive which has already been plugged into the USB slot <b>8</b> . The traces can be displayed in any regular web browser by opening the index.html file which is also located in the <i>EtrayTraces</i> folder.	<b>Remove</b>	Removes the selected trace from internal memory.	<b>Recall</b>	Loads and displays the selected trace on the screen, which can be manipulated by almost any of the functions described in this table  By selecting <b>X</b> , the loaded trace is closed and the last recorded trace is displayed again.
<b>Export</b>	Will copy the selected trace to the <i>EtrayTraces</i> folder on the USB flash drive which has already been plugged into the USB slot <b>8</b> . The traces can be displayed in any regular web browser by opening the index.html file which is also located in the <i>EtrayTraces</i> folder.						
<b>Remove</b>	Removes the selected trace from internal memory.						
<b>Recall</b>	Loads and displays the selected trace on the screen, which can be manipulated by almost any of the functions described in this table  By selecting <b>X</b> , the loaded trace is closed and the last recorded trace is displayed again.						
<p style="text-align: center;">●</p> <p><b>Adjust Trigger Delay Time</b></p>	<p>Allows manual adjustment of the trigger delay time (see page 20).</p> <table border="1" data-bbox="708 1104 1382 1236"> <tr> <td data-bbox="708 1104 878 1236" style="text-align: center;">  </td> <td data-bbox="878 1104 1382 1236" style="text-align: center;"> <p><b>CAUTION</b></p> <p><b>Adjustments outside the 0.7 to 0.9 msec window will not allow capture of the fault trace.</b></p> </td> </tr> </table> <p><b>Typical value for EZ-THUMP V2 is 0.7msec.</b></p>		<p><b>CAUTION</b></p> <p><b>Adjustments outside the 0.7 to 0.9 msec window will not allow capture of the fault trace.</b></p>				
	<p><b>CAUTION</b></p> <p><b>Adjustments outside the 0.7 to 0.9 msec window will not allow capture of the fault trace.</b></p>						
<p style="text-align: center;">●</p> <p><b>Adjust Pulse Width</b></p>	<p>Allows manual override of the automatic adjustment of the pulse width display range matrix.</p> <p>Pulse width has to be selected depending on the cable length. Narrow pulses offer higher resolution, but are limited to shorter cable length. Wide pulses offer lower resolution but can be used on longer cables. With an adjustment of the pulse width, the fault trace, if present, is erased and a new “live” trace is immediately recorded and a new fault trace must be initiated.</p>						
<p style="text-align: center;">●</p> <p><b>Find Transformers in Actually Trace</b></p>	<p>Allows manual start of the transformer (splice) search on any cable even when not in sectionalizing mode.</p> <table border="1" data-bbox="732 1709 1446 1787"> <tr> <td data-bbox="732 1709 1446 1787" style="text-align: center;"> <p><i>NOTE: Feature only available in feature menu if Sectionalizing Software is installed.</i></p> </td> </tr> </table>	<p><i>NOTE: Feature only available in feature menu if Sectionalizing Software is installed.</i></p>					
<p><i>NOTE: Feature only available in feature menu if Sectionalizing Software is installed.</i></p>							

---

## Advanced Features

If you are working in expert mode (see page 19), you can access the following advanced options via the  menu item:

Menu option	Description
<b>Move start marker</b>	Allows manual adjustment of the start marker.  <div style="border: 1px solid black; padding: 5px;"><i>NOTE: Access to <b>Start Marker</b> feature is typically "<b>Disabled</b>", instead the "<b>Additional Marker</b>" feature should be used if a second marker is required</i></div>
<b>Reset start marker</b>	Resets the start marker to default position (see page 20).  <div style="border: 1px solid black; padding: 5px;"><i>NOTE: Only required if length of HV output cable is changed, e.g. use of an additional cable reel</i></div>
<b>Disable live trace / Enable live trace</b>	Disables / enables continuous "live" trace recording.  <div style="border: 1px solid black; padding: 5px;"><i>NOTE: Typically access to live trace is disabled; most users prefer to always have a live trace that responds instantaneously- to a change in parameter setting.</i></div>



# 6

## CABLE TESTING METHODS

Select the  menu item from the main menu to access the available/factory programmed *Test Modes* of the EZ-Thump V2 according to the model ordered by the customer.

### ***DC HV Breakdown Test / DC HIPOT Test (Medium voltage cables with concentric neutral shield)***

#### **Introduction**









A HV DC Breakdown Test is applied when a cable fault is suspected, a HIPOT test is used to "proof test" a cable, which is expected to be without a fault. The only difference between the 2 test modes is that in case of the DC HIPOT Test the time function called "Continuous Testing" under the default settings is activated, allowing to set a test duration between 0 and 30 minutes. It also allows recording and saving the test data to a USB memory stick.

If the EZ-Thump V2 is typically used for fault locating of flashover faults, it is recommended to de-activate the "Continuous Testing" function; in this case the HV DC will trip automatically when the cable breaks down. If the cable does not fail, then the unit will stop the test after approximately 1 minute, displaying the message "NO Breakdown". The "Continuous Testing" function must be activated if a HIPOT Proof test is to be conducted for e.g.: a 5 minute duration (cable is expected to be without faults); the screen will display the voltage, on its left side the current is displayed and on the right side *initially* the approximate insulation resistance, which is *followed by* the remaining test duration. If in this situation the cable unexpectedly fails, the HV DC trips automatically and displays the message BREAKDOWN the associated voltage

#### **Procedure**

Proceed as follows to perform a HIPOT test:

Step	Description
1	Select the  menu item.

Step	Description						
2	Adjust the test voltage and select  to confirm the value.						
3	Press the green illuminated “HV ON” button  the red “HV-OFF” will come on. signalling that the unit in HV output mode						
4	<p>Select  to start the test (only required if <b>measurement start</b> option is set to <b>manual</b> – see section <b>Error! Not a valid result for table.</b> on page 17.)</p> <div style="border: 1px solid black; padding: 5px; margin: 5px 0;"> <p><i>NOTE: Not required when in automatic mode.</i></p> </div> <p><b>Result:</b> The selected voltage is applied to the cable.</p> <p>After the connected load is charged and the charging current has settled, the leakage current is determined during a subsequent current measurement and the resulting insulation resistance is shown in the display, with the remaining test time being shown in the right lower corner.</p> <p>Depending on whether a breakdown takes place during the test, one of the following results is presented in the display:</p> <table border="1" style="width: 100%; border-collapse: collapse;"> <tr> <td style="width: 20%;"><b>Breakdown at ... kV</b></td> <td>A voltage breakdown took place at the indicted test voltage.</td> </tr> <tr> <td><b>No Flash-over</b></td> <td>The cable has successfully withstood the applied DC test voltage. If possible, repeat () the test with higher voltage (do not exceed the maximum permissible voltage). <b>The voltage level should always be at least the equivalent DC voltage corresponding to the (rms) AC voltage under operating conditions.</b></td> </tr> <tr> <td><b>Cable not chargeable</b></td> <td>If the cable could not be charged while applying the test voltage, this typically indicates a short circuit in the cable with the output current of the HV power supply at its maximum (14mA for 12kV, 35,mA for 4kV and 43mA for 3kVunit).</td> </tr> </table>	<b>Breakdown at ... kV</b>	A voltage breakdown took place at the indicted test voltage.	<b>No Flash-over</b>	The cable has successfully withstood the applied DC test voltage. If possible, repeat (  ) the test with higher voltage (do not exceed the maximum permissible voltage). <b>The voltage level should always be at least the equivalent DC voltage corresponding to the (rms) AC voltage under operating conditions.</b>	<b>Cable not chargeable</b>	If the cable could not be charged while applying the test voltage, this typically indicates a short circuit in the cable with the output current of the HV power supply at its maximum (14mA for 12kV, 35,mA for 4kV and 43mA for 3kVunit).
<b>Breakdown at ... kV</b>	A voltage breakdown took place at the indicted test voltage.						
<b>No Flash-over</b>	The cable has successfully withstood the applied DC test voltage. If possible, repeat (  ) the test with higher voltage (do not exceed the maximum permissible voltage). <b>The voltage level should always be at least the equivalent DC voltage corresponding to the (rms) AC voltage under operating conditions.</b>						
<b>Cable not chargeable</b>	If the cable could not be charged while applying the test voltage, this typically indicates a short circuit in the cable with the output current of the HV power supply at its maximum (14mA for 12kV, 35,mA for 4kV and 43mA for 3kVunit).						
5	Select  to proceed with fault pre-location or  to return to the main menu.						

## Sheath Test / Phase to Ground Test

*(Max. Test Voltage limited to 5kV)*

*Direct buried jacketed Medium Voltage cables with concentric neutral shield*

*Direct buried LV (Low Voltage) cables without concentric shield)*

*Note: Pinpointing of a sheath fault or a phase to ground fault in LV unshielded cable is accomplished using an A-Frame or 2Spikes with a galvanometer, (Megger ESG-NT or Digiphone Plus NT, not included), please see Sheath Fault Pinpointing - (optional) LV Fault Pinpointing (unshielded cables) page 35.*



## Introduction

An intact *jacket* of a solid dielectric insulated *medium voltage cable* is the protection against water ingress in the insulation and subsequent cable faults.

With a sheath test the dielectric strength of the cable jacket can be tested by applying a DC voltage of up to 5kV (12kV unit), 4kV (4kV unit), 3kV (1.5/3kV unit) between the cable shield (metallic shield) and earth ground or the phase wire and earth ground for low cable cables.





## Connection Diagram (Sheath Test and LV Fault Locating)



*In contrast to the connection diagram on page 14*, the HV output lead has to be connected to the metallic *shield* (concentric neutral), which in turn *has to be disconnected from the grounding / bonding points on both ends of the specific cable to be tested.* Consequently, the HV return lead has to be connected directly to system ground. For LV cables the HV output is connected to one or all of the phase wires and the HV return to Earth ground together with the other phases.



## Procedure

Proceed as follows to perform a sheath test:

Step	Description
1	Select the  menu item.
2	Confirm the following two prompts regarding proper connections with  .
3	Adjust the test voltage and select  to confirm the value (maximum voltage for each unit, see <i>previous page</i> )
4	Press the green illuminated “HV ON” button  .
5	Select  to start the test (only if measurement start option is set to manual – see section “System Settings” on page 17).

Step	Description						
	<p><b>Result:</b> The selected voltage is applied to the cable.</p> <p>After the connected load is fully charged and the charging current has settled, the leakage current is determined during a subsequent current measurement and the resulting insulation resistance is shown in the display.</p> <p>Depending on whether a breakdown takes place during the test, one of the following results is presented in the display:</p>						
	<table border="1" style="width: 100%;"> <tr> <td style="width: 30%;"><b>Breakdown at ... kV</b></td> <td>A voltage breakdown took place at the indicated test voltage.</td> </tr> <tr> <td><b>No Flash-over</b></td> <td>The cable has successfully withstood the applied DC test voltage. If possible, repeat (↻) the test with higher voltage (do not exceed the maximum permissible voltage).</td> </tr> <tr> <td><b>Cable not chargeable</b></td> <td>The cable could not be charged by applying the test voltage. This is due to a short circuit in the cable.</td> </tr> </table>	<b>Breakdown at ... kV</b>	A voltage breakdown took place at the indicated test voltage.	<b>No Flash-over</b>	The cable has successfully withstood the applied DC test voltage. If possible, repeat (↻) the test with higher voltage (do not exceed the maximum permissible voltage).	<b>Cable not chargeable</b>	The cable could not be charged by applying the test voltage. This is due to a short circuit in the cable.
<b>Breakdown at ... kV</b>	A voltage breakdown took place at the indicated test voltage.						
<b>No Flash-over</b>	The cable has successfully withstood the applied DC test voltage. If possible, repeat (↻) the test with higher voltage (do not exceed the maximum permissible voltage).						
<b>Cable not chargeable</b>	The cable could not be charged by applying the test voltage. This is due to a short circuit in the cable.						
<b>6</b>	Select  to proceed with fault pre-location or  to return to the main menu.						

# 7

## CABLE FAULT PRELOCATING METHODS

Select the  menu item from the main menu to access the pre-location modes of the EZ-Thump V2, LOCATE and SECTIONALIZING.

### **Sectionalizing - (optional, special software required)**

#### **Introduction**







The use of the *Sectionalizing Mode* is typically limited to the use in North America on single phase loop type URD circuits. It identifies and indicates the location of single phase Y grounded transformers in a loop or radial system and, in the second step, identifies the faulty span of the system by using the transformer reflections as landmarks, which allow the fault reflection to be associated with the specific cable segment, defined by the closest transformer on either side of the fault.

For this purpose, a LV reflection image is taken and scanned for impedance changes which can be attributed to transformers. A second reflection image is taken while the arc ignited by a sudden discharge of the charged capacitor is present at the fault location (standard arc reflection method). This sequence can be also reversed in an alternate program called COMED, identifying and locating first the fault and in the second step the location of the transformers (all transformers up to the fault location plus one additional transformer beyond the fault).

In both versions the identification of the faulted span is done identically. By superimposing both traces, the relation between fault location (position where the two traces diverge from each other) and the 2 closest transformers can be evaluated in order to identify the faulty cable segment.

## Procedure

Proceed as follows to perform sectionalizing:

Step	Description
1	<p>Select the  menu item.</p> <p><b>Result:</b> A LV pulse is fed into the cable. The reflection image is processed by the transformer identification software. After a few seconds, the reference trace which shows the distance to the cable end and in addition, the approximate distance to each transformer is presented in the display.</p>  <p>This reference trace is also called "live" trace because it is constantly it is refreshed,</p>
2	<p>Compare the indicated transformers with the actual plans of the cable system.</p> <p>If necessary adjust the transformer search sensitivity and / or the propagation velocity in the options (on page 21).</p> <div style="border: 1px solid black; padding: 10px; margin: 10px 0;"> <p><i>NOTE: Sectionalizing is a transformer prediction algorithm based of impedance changes. If all transformers in a loop cause similar signatures the prediction works very well. If there are impedance changes for some other reasons (most likely joints) the software cannot always distinguish between them. Please always check on the distances for missing or to many transformers, typical distance between transformers 300 ft, should be at minimum 50 ft.</i></p> </div>
3	Select  to start the fault location.
4	Adjust the surge voltage and select  to confirm the value.
5	Press the green illuminated "HV ON" button  .
6	<p>Select  to charge the capacitor (only if <b>measurement start</b> option is set to <b>manual</b> – see page on page 20 ).</p> <p><b>Result:</b> The capacitor is charged up to the selected voltage.</p>
7	Select  to discharge the capacitor (only if measurement start option is set to manual – see page 20).

Step	Description
	<p><b>Result:</b> The sudden discharge of the capacitor is initiated. The fault trace, which shows the cable fault in relation to the 2 closest transformers, is presented in the display.</p> 
8	<p>If required, adjust the display settings and marker position in order to uniquely identify the faulted span (see page 22).</p>

## Pre-Location (Locate)

### Introduction







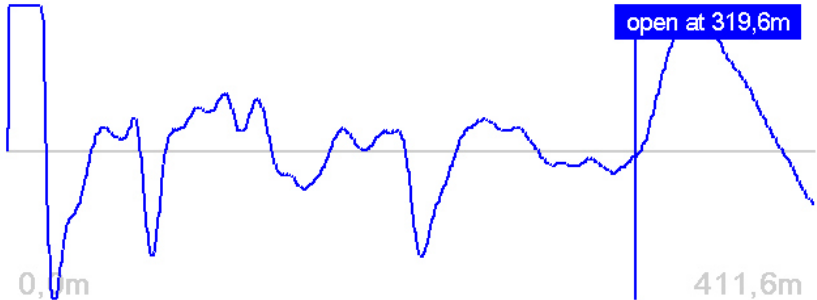

For pre-location of high resistance faults with the EZ-Thump V2, the widely approved and well-known ARM (Arc Reflection Method) is used.

Locating the fault becomes possible by comparing a reflection image taken with a LV pulse (reference trace) to a reflection image taken while the arc ignited by sudden discharge of the charged capacitor was standing at the fault location (fault trace). With this method, the two measured traces diverge at the position of the ignited arc corresponding to the fault location.

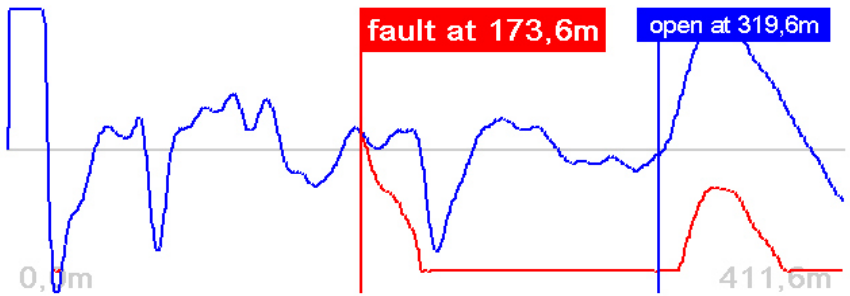

## Procedure

Proceed as follows to pre-locate the cable fault:

Step	Description
1	<p>Select the  menu item.</p> <p><b>Result:</b> A LV pulse is fed into the cable. The reflection image shows the distance to the cable end, and also defines whether the end is an "OPEN" (expected) or a "SHORT CIRCUIT" (unexpected)</p>  <p>▶ This reference trace is also called "live" trace as it is constantly refreshed.</p>
2	Select  to start the fault pre-location.
3	Press the green illuminated "HV ON" button  .
4	<p>Select  to charge the capacitor (only if <b>measurement start</b> option is set to <b>manual</b> – see page 20).</p> <p><b>Result:</b> The capacitor is charged up to 4/12 kV.</p>
5	<p>Select  to discharge the capacitor (only if measurement start option is set to manual – see page 20).</p> <p><b>Result:</b> The sudden discharge of the capacitor is initiated. The fault trace is presented in the display and the red fault marker is automatically set to the position where both traces diverge from each other.</p> 
6	<p>If required, adjust the display settings and marker position in order to identify the fault distance as precisely as possible (see page 22).</p> <p>You may also want to take another fault trace by selecting the  menu item (repeat previous step).</p>
7	Select  to proceed with pinpointing or  to return to the main menu.

# 8

## CABLE FAULT PINPOINTING

Select the  menu item from the main menu to access the pinpointing modes of the EZ-Thump V2.

### **Thumping** - High resistance Faults – Flashing Faults

#### Introduction

The thumping mode can be used to pinpoint a fault between two phase conductors, a phase and earth ground or between a phase conductor and the neutral conductor, provided a flashover can be established from the conductor to the related neutral and/or ground.



The 1.5/3kV EZ-Thump V2 allows setting the range to either 1.5kV or to 3kV depending on the maximum permissible voltage to be applied to a specific LV cable.



The EZ-Thump V2 serves as surge pulse generator to continuously feed high voltage pulses into the defective cable / phase, producing voltage flashovers (arcing) at the fault position. The resulting noise propagates through the ground and can be detected at the surface using a combination surge wave / sound wave receiver, displaying the timing difference between speed of light and speed of sound as a very accurate measure of the relative distance to the fault.

#### Procedure

Connect the HV output cable to the conductor of the (shielded) cable to be tested and the HV Return to the metallic shield. Also attach the safety ground to the system ground.

Proceed as follows to pinpoint the fault:

Step	Description
1	Select the  menu item.
2	Adjust the surge voltage and select  to confirm the value.
3	Press the green illuminated “HV ON” button  .

Step	Description
4	<p>Select  to start the thumping mode (only if <b>measurement start</b> option is set to <b>manual</b> – see page 20).</p> <p><b>Result:</b> The capacitor is charged up and a sudden discharge takes place after approximately 5 seconds or, if the charging takes longer, right after the selected surge voltage has been reached (maximum 8 seconds). This process is then repeated until thumping is manually stopped.</p> <p>If required, the surge voltage can be adjusted by selecting the  menu item.</p>
5	<p>Pinpoint the fault within the pre-located area with a surge wave receiver like Megger's Digiphone Plus.</p> <p>For detailed instructions, please refer to the user manual of the surge wave receiver.</p>
6	<p>Select  to stop thumping.</p>

## ***Sheath Fault Pinpointing - (optional)***

**Low resistance Faults – Ground / Earth Faults – Non Flashing Faults**

### ***LV Fault Pinpointing (unshielded cables)***

#### **Introduction**

Following a failed sheath test (see page 26) fault location based on the step voltage method can be immediately performed with the EZ-Thump V2 serving as surge pulse generator.

The current and voltage associated with the HV pulse enter the ground at the point of fault and result in a step potential on the overlying earth surface. This step potential can be detected with an earth gradient monitor type fault locator (typically A-Frame). When approaching the fault position, the step voltage increases exponentially and become zero directly over the fault. The step voltage will then change to the maximum ***opposite polarity*** when going on the other side of the fault and then decreasing with increasing distance from the fault.







## Connections

In contrast to the connection diagram on page 14 the HV output lead has to be connected to the metallic shield (concentric neutral) which in turn has to be disconnected from ground on both ends of the specific cable to be tested. Consequently, the HV return lead has to be connected directly to system ground.



## Procedure

Proceed as follows to pinpoint the sheath fault:

Step	Description
1	Select the  menu item.
2	Confirm the following two notices with  .
3	Adjust the voltage and select  to confirm the value (Maximum 5kV)
4	Press the green illuminated "HV ON" button  .
5	Select  to start the thumping mode (only if <b>measurement start</b> option is set to <b>manual</b> – see page 20).  <b>Result:</b> The capacitor is charged up and a sudden discharge takes place after 5. This process is then repeated until thumping is manually stopped. If required, you can adjust the voltage by selecting the  menu item.
6	Pinpoint the sheath fault with an earth fault locator like Megger's ESG-NT or DigiphonePlus NT. For detailed instructions, please refer to the user manual of the Earth Fault Locator.
7	Select  to stop thumping.

**Megger.**

# 9

## COMPLETION OF OPERATION

### *Switching Off*

After the fault location procedure has been finished press the "HV OFF" button **5**. Switch the system off by pressing the "ON / OFF" button **7**.

### *Disconnecting the Test Object*

The test object is to be grounded and shorted. Afterwards, the unit can be disconnected from the test object.



#### **WARNING**

- Follow the five safety rules described on page on page 3.
- **Circuit and System components which have been energized must not be touched, unless they have been properly discharged and are visibly grounded.**
- **Leave the grounding measures in place until the test object is to be put into operation again.**

**Megger.**

# 10

## MAINTENANCE

### ***Storage***

If not in use, the system should be stored in a dust free and dry environment. Humidity (condensation) by itself or in combination with dust can reduce critical distances within the equipment, which are necessary to maintain safe high voltage performance.

When storing the unit or when the unit is not in use, make sure to keep the AC line cord connected to an active outlet in order to maintain the charge and or the trickle charge.

### ***Battery Replacement***

Should it become necessary to replace the 24V NiMH battery, please contact the Customer Service Department at the Megger Valley Forge Plant and request a step-by-step replacement procedure:

VFcustomersupport@megger.com

800-723-2861 (USA)

+1 610 676 8500



**Megger.**



# APPENDIX 1

## “Help Menu” to Configure TDR Features in “Quick Steps” and “Expert Mode” Menus

### “MENU LOCATE OPTIONS”



20 User Options are available, which require to be configured for each Menu Style of operation, either as

- **Simple Option** means this feature is accessible by activating the  symbol on the screen. Features are set up as “Simple Options” if they are frequently used. It also depends on the skill set of the operators.
- **Extended Option** means this feature is accessible by clicking on the  symbol on the screen. Features are set up as “Extended Options” if they are only used occasionally, but are still accessible from the active menu without having to go to a different menu.
- "Disabled Option" means this feature is set up to be *not* accessible for “Quick Steps” or both “Quick-Steps” and "Expert" menus. It is also possible to make a feature accessible in “Quick-Steps”, but *not* in “Expert” but this would be very unusual.

This allows the customer to create "customer specific menus" to operate TDR functions with 2 different access right levels. See below, each screen contains 3 options, only the first one is highlighted in each box for illustration purposes.

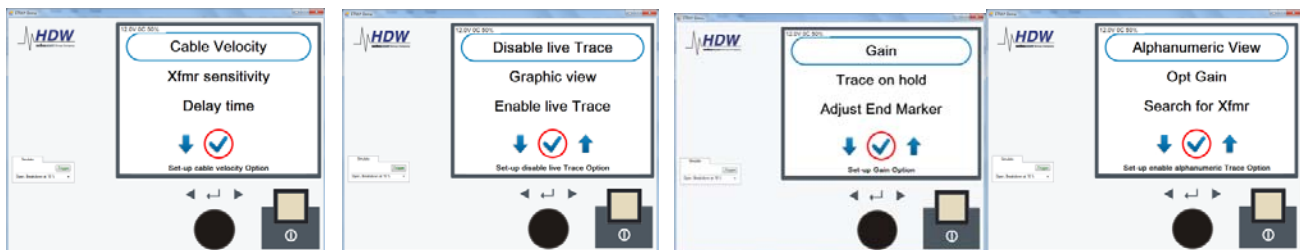

# SONDE DETECTION AND LOCATING

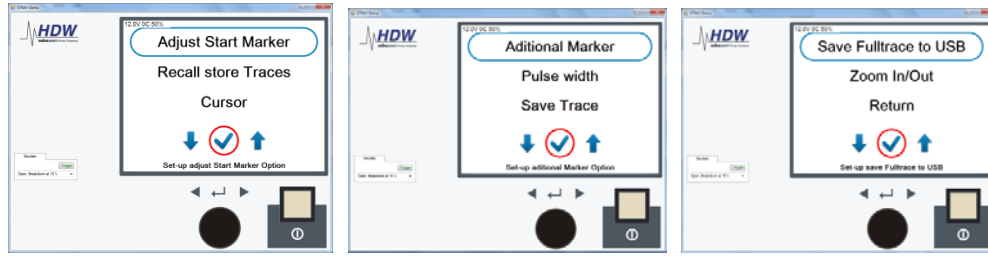

**SELECTION TABLE (Mark with X) to document users selected TDR features.**

	OPTION	QUICK-STEPS			EXPERT		
		Simple Option	Extended Option	Disabled Option	Simple Option	Extended Option	Disabled Option
G	Cable Velocity						
R	Xfmr Sensitivity						
Y	Delay Time						
Y	Disable live Trace						
Y	Graphic view						
Y	Enable live Trace						
Y	Alphanumeric View						
B	Opt Gain						
R	Search for Xfmr						
R	Gain						
R	Trace on hold						
R	Adjust End Marker						
Y	Adjust Start Marker						
R	Recall Stored Traces						
G	Cursor						
R	Additional Marker						
R	Pulse Width						
G	Save Trace						
B	Save Full Trace to USB						
R	Zoom In/Out						

G	<b>Green Features:</b> recommended to be "Simple Options" in both "Quick-Steps" and "Expert" Menu Style
R	<b>Red Features:</b> recommended to be "simple" option in Expert Menu Style
Y	<b>Yellow Features:</b> recommended to "be" "Extended Options" in "Expert" Menu Style

---

<b>B</b>	<i>Blue Features: Reserved for Service Menu (no customer access)</i>
----------	--

## APPENDIX 2

### **Special Customized - Permanently Mounted Wheel Kit**

Will be available in the future for all EZ-Thumps V2 models, however *heavily modified* compared to photo below.



**Megger.**