

FLUKE®

1735
Power Logger

Users Manual

2560330

March 2006 Rev.1, 4/06

© 2006 Fluke Corporation, All rights reserved.

All product names are trademarks of their respective companies.

LIMITED WARRANTY AND LIMITATION OF LIABILITY

Each Fluke product is warranted to be free from defects in material and workmanship under normal use and service. The warranty period is two years and begins on the date of shipment. Parts, product repairs, and services are warranted for 90 days. This warranty extends only to the original buyer or end-user customer of a Fluke authorized reseller, and does not apply to fuses, disposable batteries, or to any product which, in Fluke's opinion, has been misused, altered, neglected, contaminated, or damaged by accident or abnormal conditions of operation or handling. Fluke warrants that software will operate substantially in accordance with its functional specifications for 90 days and that it has been properly recorded on non-defective media. Fluke does not warrant that software will be error free or operate without interruption.

Fluke authorized resellers shall extend this warranty on new and unused products to end-user customers only but have no authority to extend a greater or different warranty on behalf of Fluke. Warranty support is available only if product is purchased through a Fluke authorized sales outlet or Buyer has paid the applicable international price. Fluke reserves the right to invoice Buyer for importation costs of repair/replacement parts when product purchased in one country is submitted for repair in another country.

Fluke's warranty obligation is limited, at Fluke's option, to refund of the purchase price, free of charge repair, or replacement of a defective product which is returned to a Fluke authorized service center within the warranty period.

To obtain warranty service, contact your nearest Fluke authorized service center to obtain return authorization information, then send the product to that service center, with a description of the difficulty, postage and insurance prepaid (FOB Destination). Fluke assumes no risk for damage in transit. Following warranty repair, the product will be returned to Buyer, transportation prepaid (FOB Destination). If Fluke determines that failure was caused by neglect, misuse, contamination, alteration, accident, or abnormal condition of operation or handling, including overvoltage failures caused by use outside the product's specified rating, or normal wear and tear of mechanical components, Fluke will provide an estimate of repair costs and obtain authorization before commencing the work. Following repair, the product will be returned to the Buyer transportation prepaid and the Buyer will be billed for the repair and return transportation charges (FOB Shipping Point).

THIS WARRANTY IS BUYER'S SOLE AND EXCLUSIVE REMEDY AND IS IN LIEU OF ALL OTHER WARRANTIES, EXPRESS OR IMPLIED, INCLUDING BUT NOT LIMITED TO ANY IMPLIED WARRANTY OF MERCHANTABILITY OR FITNESS FOR A PARTICULAR PURPOSE. FLUKE SHALL NOT BE LIABLE FOR ANY SPECIAL, INDIRECT, INCIDENTAL OR CONSEQUENTIAL DAMAGES OR LOSSES, INCLUDING LOSS OF DATA, ARISING FROM ANY CAUSE OR THEORY.

Since some countries or states do not allow limitation of the term of an implied warranty, or exclusion or limitation of incidental or consequential damages, the limitations and exclusions of this warranty may not apply to every buyer. If any provision of this Warranty is held invalid or unenforceable by a court or other decision-maker of competent jurisdiction, such holding will not affect the validity or enforceability of any other provision.

Fluke Corporation
P.O. Box 9090
Everett, WA 98206-9090
U.S.A.

Fluke Europe B.V.
P.O. Box 1186
5602 BD Eindhoven
The Netherlands

LIMITES DE GARANTIE ET DE RESPONSABILITE

La société Fluke garantit l'absence de vices de matériaux et de fabrication de ses produits dans des conditions normales d'utilisation et d'entretien. La période de garantie est de deux ans et prend effet à la date d'expédition. Les pièces, les réparations de produit et les services sont garantis pendant une période de 90 jours. Cette garantie ne s'applique qu'à l'acheteur d'origine ou à l'utilisateur final s'il est client d'un distributeur agréé par Fluke, et ne s'applique pas aux fusibles, aux batteries/piles interchangeables ni à aucun produit qui, de l'avis de Fluke, a été malmené, modifié, négligé, contaminé ou endommagé par accident ou soumis à des conditions anormales d'utilisation et de manipulation. Fluke garantit que le logiciel fonctionnera en grande partie conformément à ses spécifications fonctionnelles pendant une période de 90 jours et qu'il a été correctement enregistré sur des supports non défectueux. Fluke ne garantit pas que le logiciel est exempt d'erreurs ou qu'il fonctionnera sans interruption.

Les distributeurs agréés par Fluke appliqueront cette garantie à des produits vendus neufs et qui n'ont pas servi, mais ne sont pas autorisés à offrir une garantie plus étendue ou différente au nom de Fluke. Le support de garantie est offert uniquement si le produit a été acquis par l'intermédiaire d'un point de vente agréé par Fluke ou bien si l'acheteur a payé le prix international applicable. Fluke se réserve le droit de facturer à l'acheteur les frais d'importation des pièces de réparation ou de remplacement si le produit acheté dans un pays a été expédié dans un autre pays pour y être réparé.

L'obligation de garantie de Fluke est limitée, au choix de Fluke, au remboursement du prix d'achat, ou à la réparation/remplacement gratuit d'un produit défectueux retourné dans le délai de garantie à un centre de service agréé par Fluke.

Pour avoir recours au service de la garantie, mettez-vous en rapport avec le centre de service agréé Fluke le plus proche pour recevoir les références d'autorisation de renvoi, ou envoyez le produit, accompagné d'une description du problème, port et assurance payés (franco lieu de destination), à ce centre de service. Fluke décline toute responsabilité en cas de dégradations survenues au cours du transport. Après la réparation sous garantie, le produit est renvoyé à l'acheteur, frais de port payés d'avance (franco lieu de destination). Si Fluke estime que le problème est le résultat d'une négligence, d'un traitement abusif, d'une contamination, d'une modification, d'un accident ou de conditions de fonctionnement ou de manipulation anormales, notamment de surtensions liées à une utilisation du produit en dehors des spécifications nominales, ou de l'usure normale des composants mécaniques, Fluke fournira un devis des frais de réparation et ne commencera la réparation qu'après en avoir reçu l'autorisation. Après la réparation, le produit est renvoyé à l'acheteur, en port payé (franco point d'expédition) et les frais de réparation et de transport lui sont facturés.

**LA PRESENTE GARANTIE EST EXCLUSIVE ET TIENT LIEU DE TOUTES AUTRES GARANTIES, EXPRESSES OU IMPLICITES, Y COMPRIS, MAIS NON EXCLUSIVE-
MENT, TOUTE GARANTIE IMPLICITE DE VALEUR MARCHANDE OU D'ADEQUATION
A UN USAGE PARTICULIER. FLUKE NE POURRA ETRE TENU RESPONSABLE
D'AUCUN DOMMAGE PARTICULIER, INDIRECT, ACCIDENTEL OU CONSECUTIF, NI
D'AUCUN DEGAT OU PERTE, DE DONNEES NOTAMMENT, SUR UNE BASE
CONTRACTUELLE, EXTRA-CONTRACTUELLE OU AUTRE.**

Etant donné que certaines juridictions n'admettent pas les limitations d'une condition de garantie implicite, ni l'exclusion ou la limitation des dommages directs ou indirects, il se peut que les limitations et les exclusions de cette garantie ne s'appliquent pas à chaque acheteur. Si une disposition quelconque de cette garantie est jugée non valide ou inapplicable par un tribunal ou un autre pouvoir décisionnel compétent, une telle décision n'affectera en rien la validité ou le caractère exécutoire de toute autre disposition.

Fluke Corporation
P.O. Box 9090
Everett, WA 98206-0777
États-Unis

Fluke Europe B.V.
P.O. Box 1186
5602, boul. Eindhoven
Pays-Bas

BESCHRÄNKTE GARANTIE UND HAFTUNGSBEGRENZUNG

Fluke gewährleistet, dass jedes Fluke-Produkt unter normalem Gebrauch und Service frei von Material- und Fertigungsdefekten ist. Die Garantiedauer beträgt zwei Jahre ab Versanddatum. Ersatzteile, Produktreparaturen und Servicearbeiten haben eine Garantie von 90 Tagen. Diese Garantie wird ausschließlich dem Ersterwerber bzw. dem Endverbraucher, der das betreffende Produkt von einer von Fluke autorisierten Verkaufsstelle erworben hat, geleistet und erstreckt sich nicht auf Sicherungen, Einwegbatterien oder irgendwelche anderen Produkte, die nach dem Ermessen von Fluke unsachgemäß verwendet, verändert, vernachlässigt, verunreinigt, durch Unfälle beschädigt oder abnormalen Betriebsbedingungen oder einer unsachgemäßen Handhabung ausgesetzt wurden. Fluke garantiert für einen Zeitraum von 90 Tagen, dass die Software im Wesentlichen in Übereinstimmung mit den einschlägigen Funktionsbeschreibungen funktioniert und dass diese Software auf fehlerfreien Datenträgern gespeichert wurde. Fluke übernimmt jedoch keine Garantie dafür, dass die Software fehlerfrei ist und störungsfrei arbeitet.

Von Fluke autorisierte Verkaufsstellen dürfen diese Garantie ausschließlich für neue und nicht benutzte, an Endverbraucher verkaufte Produkte leisten. Die Verkaufsstellen sind jedoch nicht dazu berechtigt, diese Garantie im Namen von Fluke zu verlängern, auszudehnen oder in irgendeiner anderen Weise abzuändern. Der Käufer hat nur dann das Recht, aus der Garantie abgeleitete Unterstützungsleistungen in Anspruch zu nehmen, wenn das Produkt bei einer von Fluke autorisierten Vertriebsstelle erworben oder der jeweils geltende internationale Preis gezahlt wurde. Fluke behält sich das Recht vor, dem Käufer Einfuhrgebühren für Ersatzteile in Rechnung zu stellen, falls der Käufer das Produkt nicht in dem Land zur Reparatur einsendet, in dem er das Produkt ursprünglich erworben hat.

Die Garantieverpflichtung von Fluke beschränkt sich darauf, dass Fluke nach eigenem Ermessen den Kaufpreis ersetzt oder aber das defekte Produkt unentgeltlich repariert oder austauscht, wenn dieses Produkt innerhalb der Garantiefrist einem von Fluke autorisierten Servicezentrum zur Reparatur übergeben wird.

Um die Garantieleistung in Anspruch zu nehmen, wenden Sie sich bitte an das nächstgelegene von Fluke autorisierte Servicezentrum, um Rücknahmeinformationen zu erhalten, und senden Sie dann das Produkt mit einer Beschreibung des Problems und unter Vorauszahlung von Fracht- und Versicherungskosten (FOB-Bestimmungsort) an das nächstgelegene von Fluke autorisierte Servicezentrum. Fluke übernimmt keine Haftung für Transportschäden. Im Anschluss an die Reparatur wird das Produkt unter Vorauszahlung der Frachtkosten (Frachtfrei-Bestimmungsort) an den Käufer zurückgesandt. Wenn Fluke feststellt, dass der Defekt auf Vernachlässigung, unsachgemäße Handhabung, Verunreinigung, Veränderungen am Gerät, einen Unfall oder auf anormale Betriebsbedingungen, einschließlich durch außerhalb der für das Produkt spezifizierten Belastbarkeit verursachter Überspannungsfehler oder normaler Abnutzung mechanischer Komponenten, zurückzuführen ist, wird Fluke dem Erwerber einen Voranschlag der Reparaturkosten zukommen lassen und erst die Zustimmung des Erwerbers einholen, bevor die Arbeiten in Angriff genommen werden. Nach der Reparatur wird das Produkt unter Vorauszahlung der Frachtkosten an den Käufer zurückgeschickt, und es werden dem Käufer die Reparaturkosten und die Versandkosten (Frachtfrei-Versandort) in Rechnung gestellt.

DIE VORSTEHENDEN GARANTIEBESTIMMUNGEN STELLEN DEN EINZIGEN UND ALLEINIGEN RECHTSANSPRUCH AUF SCHADENERSATZ DES KÄUFERS DAR UND GELTEN AUSSCHLIESSLICH UND AN STELLE ALLER ANDEREN VERTRAGLICHEN ODER GESETZLICHEN GEWÄHRLEISTUNGSPFLICHTEN, EINSCHLIESSLICH - JEDOCH NICHT DARAUf BESCHRÄNKt - DER GESETZLICHEN GEWÄHRLEISTUNG DER MARKTFÄHIGKEIT UND DER EIGNUNG FÜR EINEN BESTIMMTEN ZWECK. FLUKE HAFTET NICHT FÜR SPEZIELLE, UNMITTELBARE, MITTELBARE, BEGLEIT- ODER FOLGESCHÄDEN ODER VERLUSTE, EINSCHLIESSLICH VERLUST VON DATEN, UNABHÄNGIG VON DER URSACHE ODER THEORIE.

In einigen Ländern ist die Begrenzung einer gesetzlichen Gewährleistung und der Ausschluss oder die Begrenzung von Begleit- oder Folgeschäden nicht zulässig, sodass die oben genannten Einschränkungen und Ausschlüsse möglicherweise nicht für jeden Käufer gelten. Sollte eine Klausel dieser Garantiebestimmungen von einem zuständigen Gericht oder einer anderen Entscheidungsinstanz für unwirksam oder nicht durchsetzbar befunden werden, so bleiben die Wirksamkeit oder Durchsetzbarkeit anderer Klauseln dieser Garantiebestimmungen von einem solchen Spruch unberührt.

Fluke Corporation
P.O. Box 9090
Everett, WA 98206-9090
USA

Fluke Europe B.V.
P.O. Box 1186
5602 BD Eindhoven
Niederlande

GARANZIA LIMITATA E LIMITAZIONE DI RESPONSABILITÀ

Si garantisce che ogni prodotto Fluke è esente da difetti nei materiali e nella manodopera per normali situazioni di uso. Il periodo di garanzia è di due anni a decorrere dalla data di spedizione. La garanzia sulle parti sostituite, sulle riparazioni e sugli interventi di assistenza è di 90 giorni. La garanzia è valida solo per l'acquirente originale o l'utente finale che abbia acquistato il prodotto presso un rivenditore Fluke autorizzato. Sono esclusi i fusibili, le pile monouso e i prodotti che, a parere della Fluke, siano stati adoperati in modo improprio, alterati, trascurati, contaminati o danneggiati in seguito a incidente o condizioni anomale d'uso e maneggiamento. La Fluke garantisce che il software funzionerà sostanzialmente secondo le specifiche per un periodo di 90 giorni e che è stato registrato su supporti non difettosi. Non garantisce che il software sarà esente da errori o che funzionerà senza interruzioni.

I rivenditori autorizzati Fluke estenderanno la garanzia sui prodotti nuovi o non usati esclusivamente ai clienti finali, ma non potranno emettere una garanzia differente o più completa a nome della Fluke. La garanzia è valida solo se il prodotto è stato acquistato attraverso la rete commerciale Fluke o se l'acquirente ha pagato il prezzo internazionale pertinente. La Fluke si riserva il diritto di fatturare all'acquirente i costi di importazione per la riparazione/sostituzione delle parti nel caso in cui il prodotto acquistato in un Paese sia sottoposto a riparazione in un altro.

L'obbligo di garanzia è limitato, a scelta della Fluke, al rimborso del prezzo d'acquisto, alla riparazione gratuita o alla sostituzione di un prodotto difettoso che sia inviato ad un centro di assistenza autorizzato Fluke entro il periodo di garanzia.

Per usufruire dell'assistenza in garanzia, rivolgersi al più vicino centro di assistenza autorizzato Fluke per ottenere informazioni sull'autorizzazione alla restituzione, quindi spedire il prodotto al centro di assistenza, allegando una descrizione del difetto, franco destinatario e assicurato. La Fluke declina ogni responsabilità di danni durante il trasporto. Una volta eseguite le riparazioni in garanzia, il prodotto sarà restituito all'acquirente, franco destinatario. Se la Fluke stabilisce che il guasto è stato causato da negligenza, uso improprio, contaminazione, alterazione, incidente o condizioni anomale di uso o maneggiamento (comprese le sovratensioni causate dall'uso dello strumento oltre la portata nominale e l'usura dei componenti meccanici dovuta all'uso normale dello strumento), la Fluke darà una stima dei costi di riparazione e attenderà l'autorizzazione dell'utente prima di procedere con la riparazione. A seguito della riparazione, il prodotto sarà restituito all'acquirente con addebito delle spese di riparazione e di spedizione.

LA PRESENTE GARANZIA È L'UNICO ED ESCLUSIVO RICORSO DISPONIBILE ALL'ACQUIRENTE ED È EMessa IN SOSTITUZIONE DI OGNI ALTRA GARANZIA, ESPRESSA O IMPLICITA, COMPRESA, MA NON LIMITATA A ESSA, QUALSIASI GARANZIA IMPLICITA DI COMMERCIALIZZABILITÀ O DI IDONEITÀ PER SCOPI PARTICOLARI. LA FLUKE NON SARÀ RESPONSABILE DI NESSUN DANNO O PERDITA SPECIALI, INDIRETTI O ACCIDENTALI, DERIVANTI DA QUALUNQUE CAUSA O TEORIA.

Poiché alcuni Paesi non consentono di limitare i termini di una garanzia implicita né l'esclusione o la limitazione di danni accidentali o indiretti, le limitazioni e le esclusioni della presente garanzia possono non valere per tutti gli acquirenti. Se una clausola qualsiasi della presente garanzia non è ritenuta valida o attuabile dal tribunale o altro foro competente, tale giudizio non avrà effetto sulla validità delle altre clausole.

Fluke Corporation
P.O. Box 9090
Everett, WA 98206-9090
USA

Fluke Europe B.V.
P.O. Box 1186
5602 BD Eindhoven
Paesi Bassi

GARANTIA LIMITADA E LIMITAÇÃO DE RESPONSABILIDADE

Todos os produtos da Fluke são garantidos contra defeitos de material e de mão-de-obra, sob condições de uso e serviço normal. O período de garantia é de dois anos, a partir da data de remessa do produto. As peças, reparos do produto, e serviços são garantidos por 90 dias. Esta garantia aplica-se apenas ao comprador original, ou ao cliente usuário-final de um revendedor autorizado da Fluke, e não cobre fusíveis, baterias descartáveis, nem qualquer produto que, na opinião da Fluke, tenha sido usado de forma inadequada, alterado, contaminado, ou tenha sido danificado por acidente ou condições anormais de operação ou manuseio. A Fluke garante que o software funcionará de acordo com as suas especificações técnicas pelo período de 90 dias, e que foi gravado de forma adequada em meio físico sem defeitos. A Fluke não garante que o software não apresentará erros nem que funcionará ininterruptamente.

Os revendedores Fluke autorizados devem conceder esta garantia somente para produtos novos e não-usados, mas não estão autorizados a ampliá-la ou modificá-la de qualquer forma em nome da Fluke. A assistência técnica coberta pela garantia está disponível se o produto houver sido adquirido de uma loja autorizada da Fluke, ou se o Comprador tiver pago o preço internacional aplicável. A Fluke reserva-se o direito de cobrar do Comprador os custos de importação das peças de reposição/reparo nos casos em que o produto tenha sido comprado em um país e remetido para reparos em outro país.

A obrigação da Fluke no tocante a esta garantia é limitada, a critério da Fluke, à devolução da importância correspondente ao preço pago pelo produto, a consertos gratuitos, ou à substituição de produto defeituoso que seja devolvido a um centro de assistência técnica autorizado Fluke dentro do período coberto pela garantia.

Para obter serviços cobertos pela garantia, entre em contato com o centro de assistência técnica autorizado Fluke mais próximo, ou remeta o produto, com uma descrição do problema encontrado e com frete e seguro pagos (FOB no destino), ao centro de assistência técnica mais próximo. A Fluke não se responsabiliza por nenhum dano que possa ocorrer durante o transporte. Após serem efetuados os serviços cobertos pela garantia, o produto será remetido de volta ao Comprador, com frete pago (FOB no destino). Se a Fluke constatar que a falha do produto foi causada por negligência, uso inadequado, contaminação, alterações, acidente, ou condições anormais de operação ou manuseio, inclusive falhas devidas a sobretensão causadas pelo uso do produto fora das faixas e classificações especificadas, ou pelo desgaste normal de componentes mecânicos, a Fluke dará uma estimativa dos custos de reparo, e obterá autorização do Comprador antes de efetuar tais reparos. Após a realização dos reparos, o produto será remetido de volta ao Comprador com frete pago, e este reembolsará a Fluke pelos custos do reparo e da remessa (FOB no local de remessa).

ESTA GARANTIA É O ÚNICO E EXCLUSIVO RECURSO JURÍDICO DO COMPRADOR, E SUBSTITUI TODAS AS OUTRAS GARANTIAS, EXPRESSAS OU IMPLÍCITAS, INCLUINDO, MAS NÃO SE LIMITANDO A, QUALQUER GARANTIA IMPLÍCITA DE COMERCIABILIDADE OU ADEQUAÇÃO PARA UM DETERMINADO FIM. A FLUKE NÃO SE RESPONSABILIZA POR NENHUM DANO OU PERDA, INCIDENTAL OU CONSEQÜENTE, QUE POSSA OCORRER POR QUALQUER MOTIVO OU QUE SEJA DECORRENTE DE QUALQUER CAUSA OU TEORIA JURÍDICA.

Como alguns estados ou países não permitem a exclusão ou limitação dos termos de garantias implícitas, nem de danos incidentais ou conseqüentes, esta limitação de responsabilidade poderá não se aplicar ao seu caso. Se alguma provisão desta Garantia for considerada inválida ou inexecutável por algum tribunal ou outro órgão de jurisdição competente, tal decisão judicial não afetará a validade ou exequibilidade de nenhuma outra provisão.

Fluke Corporation
P.O. Box 9090
Everett, WA 98206-9090,
EUA

Fluke Europe B.V.
P.O. Box 1186
5602 BD Eindhoven
Holanda

GARANTÍA LIMITADA Y LIMITACIÓN DE RESPONSABILIDAD

Todo producto de Fluke está garantizado contra defectos en los materiales y en la mano de obra en condiciones normales de utilización y mantenimiento. El periodo de garantía es de tres años y comienza en la fecha de despacho. Las piezas de repuesto, reparaciones y servicios están garantizados por 90 días. Esta garantía se extiende sólo al comprador original o al cliente usuario final de un revendedor autorizado por Fluke y no es válida para fusibles, baterías desechables ni para ningún producto que, en opinión de Fluke, haya sido utilizado incorrectamente, modificado, maltratado, contaminado, o sufrido daño accidental o por condiciones anormales de funcionamiento o manipulación. Fluke garantiza que el software funcionará substancialmente de acuerdo con sus especificaciones funcionales durante 90 días y que ha sido grabado correctamente en un medio magnético sin defectos. Fluke no garantiza que el software no contenga errores ni que operará permanentemente.

Los revendedores autorizados por Fluke podrán extender esta garantía solamente a los Compradores finales de productos nuevos y sin uso previo, pero carecen de autoridad para extender una garantía mayor o diferente en nombre de Fluke. El soporte técnico en garantía está disponible sólo si el producto se compró a través de un centro de distribución autorizado por Fluke o si el comprador pagó el precio internacional correspondiente. Cuando un producto comprado en un país sea enviado a otro país para su reparación, Fluke se reserva el derecho de facturar al Comprador los gastos de importación de las reparaciones/repuestos.

La obligación de Fluke de acuerdo con la garantía está limitada, a elección de Fluke, al reembolso del precio de compra, la reparación gratuita o el reemplazo de un producto defectuoso que sea devuelto a un centro de servicio autorizado de Fluke dentro del periodo de garantía.

Para obtener servicio de garantía, póngase en contacto con el centro de servicio autorizado por Fluke más cercano para obtener la información correspondiente a la autorización de la devolución, después envíe el producto a ese centro de servicio, con una descripción del fallo, con los portes y seguro prepagados (FOB destino). Fluke no se hace responsable de los daños ocurridos durante el transporte. Después de la reparación de garantía, el producto se devolverá al Comprador con los fletes ya pagados (FOB destino). Si Fluke determina que el problema fue debido a negligencia, mala utilización, contaminación, modificación, accidente o una condición anormal de funcionamiento o manipulación, incluidas las fallas por sobreten-sión causadas por el uso fuera de los valores nominales especificados para el producto, o al desgaste normal de los componentes mecánicos, Fluke preparará una estimación de los costes de reparación y obtendrá la debida autorización antes de comenzar el trabajo. Al concluir la reparación, el producto se devolverá al Comprador con los fletes ya pagados, facturándosele la reparación y los gastos de transporte (FOB en el sitio de despacho).

ESTA GARANTÍA ES EL ÚNICO Y EXCLUSIVO RECURSO DEL COMPRADOR Y SUBSTITUYE A TODAS LAS OTRAS GARANTÍAS, EXPRESAS O IMPLÍCITAS, INCLUYENDO, PERO SIN LIMITARSE A, TODA GARANTÍA IMPLÍCITA DE COMERCIABILIDAD O IDONEIDAD PARA UN PROPÓSITO DETERMINADO. FLUKE NO SE RESPONSABILIZA DE PÉRDIDAS NI DAÑOS ESPECIALES, INDIRECTOS, IMPREVISTOS O CONTINGENTES, INCLUIDA LA PÉRDIDA DE DATOS, QUE SURJAN POR CUALQUIER TIPO DE CAUSA O TEORÍA.

Como algunos países o estados no permiten la limitación de la duración de una garantía implícita ni la exclusión ni limitación de los daños contingentes o resultantes, las limitaciones y exclusiones de esta garantía pueden no regir para todos los Compradores. Si una cláusula de esta Garantía es conceptuada no válida o inaplicable por un tribunal u otra instancia de jurisdicción competente, tal concepto no afectará la validez o aplicabilidad de cualquier otra cláusula.

Fluke Corporation
P.O. Box 9090
Everett, WA 98206-9090
EE.UU.

Fluke Europe B.V.
P.O. Box 1186
5602 BD Eindhoven
Holanda

有限担保和有限责任

Fluke 担保在正常使用和保养的情况下，其产品没有材料和工艺上的缺陷。两年的担保期间由产品发货之日算起。部件、产品修理和服务的担保期限为 90 天。本担保仅限于 **Fluke** 授权零售商的原购买人或最终用户，并且不适用于一次性电池、电缆接头、电缆绝缘转换接头或 **Fluke** 认为由于误用、改装、疏忽、污染及意外或异常操作或处理引起的任何产品损坏。**Fluke** 担保软件能依照功能规格正常运行 90 天，并且软件是记录在无缺陷的媒介上。**Fluke** 并不担保软件毫无错误或在运行中不会中断。

Fluke 授权的零售商应仅对最终用户就新的和未使用的产品提供本担保，但无权代表 **Fluke** 公司提供额外或不同的担保。只有通过 **Fluke** 授权的销售店购买的产品或者买方已经按适用的国际价格付款才能享受 **Fluke** 的担保支持。在一国购买的产品需在他国修理时，**Fluke** 有权向买方要求负担重大修理/零件更换费用。

Fluke 的担保为有限责任，由 **Fluke** 决定是否退还购买金额、免费修理或更换在担保期间退还 **Fluke** 授权服务中心的故障产品。

如需要保修服务，请与您就近的 **Fluke** 授权服务中心联系，获得退还授权信息；然后将产品寄至服务中心，并附上产品问题描述，同时预付运费和保险费（目的地离岸价格）。**Fluke** 不承担运送途中发生的损坏。在保修之后，产品将被寄回给买方并提前支付运输费（目的地交货）。如果 **Fluke** 认定产品故障是由于疏忽、误用、污染、修改、意外或不当操作或处理状况而产生，包括未在产品规定的额定值下使用引起的过压故障；或是由于机件日常使用损耗，则 **Fluke** 会估算修理费用，在获得买方同意后再进行修理。在修理之后，产品将被寄回给买方并预付运输费；买方将收到修理和返程运输费用（寄发地交货）的帐单。

本担保为买方唯一能获得的全部补偿内容，并且取代所有其它明示或隐含的担保，包括但不限于适销性或满足特殊目的任何隐含担保。**FLUKE** 对任何特殊、间接、偶发或后续的损坏或损失概不负责，包括由于任何原因或推理引起的数据丢失。

由于某些国家或州不允许对隐含担保的期限加以限制、或者排除和限制意外或后续损坏，本担保的限制和排除责任条款可能并不对每一个买方都适用。如果本担保的某些条款被法院或其它具有适当管辖权的裁决机构判定为无效或不可执行，则此类判决将不影响任何其它条款的有效性或可执行性。

Fluke Corporation
P.O. Box 9090
Everett, WA 98206-9090
U.S.A.

Fluke Europe B.V.
P.O. Box 1186
5602 BD Eindhoven
The Netherlands

Table of Contents

| Title | Page |
|--|------|
| Introduction | 1 |
| Symbols | 1 |
| Safety Instructions | 2 |
| Standard and Optional Accessories..... | 3 |
| Software and Information CD..... | 5 |
| Instrument Familiarity | 5 |
| Current Probes | 5 |
| Control Elements, Display | 5 |
| Display Symbols | 6 |
| Description of the Control Elements..... | 7 |
| Using the SAVE and CURSOR Keys | 7 |
| Connectors | 8 |
| RS-232 Interface | 8 |
| Basic Adjustments (Menu)..... | 9 |
| Menu Structuring | 9 |
| Short Overview of the Menu..... | 9 |
| Basic Operation | 10 |
| Parameter Configuration | 11 |
| Logging Menu..... | 11 |
| View/Delete Screenshots | 12 |
| View Auto Screenshots..... | 13 |
| Display Contrast | 14 |
| Instrument Setup | 15 |
| Current Probes | 15 |
| Voltage Transformers | 17 |
| Phase Identification..... | 17 |
| Backlight..... | 17 |
| Version & Calibration..... | 17 |
| Power Network | 18 |
| Date & Time | 18 |
| Language | 18 |
| Measuring Functions..... | 18 |
| Overview | 18 |
| Meter Volts / Amps / Hz..... | 19 |
| Scope | 19 |

| | |
|--|----|
| Harmonics | 19 |
| Power..... | 19 |
| Events..... | 20 |
| Connecting the Power Logger to the Network | 20 |
| Color Coding Wire Clips..... | 20 |
| Single and Split Phase Connections | 20 |
| Split Phase..... | 22 |
| Measurement in a Three-Phase Power Network..... | 23 |
| Volts / Amps / Hertz..... | 25 |
| Logging | 25 |
| Measurement | 26 |
| Save | 26 |
| Logging Function | 27 |
| Power | 28 |
| Measurement | 28 |
| Three-Phase Power Theory | 30 |
| Save..... | 31 |
| Logging Function | 32 |
| Logging | 33 |
| Events..... | 33 |
| Save | 35 |
| Logged Events..... | 35 |
| Harmonics | 35 |
| Measurement | 35 |
| Logger Function | 37 |
| Logging | 38 |
| Save..... | 38 |
| Scope..... | 38 |
| Measurement | 39 |
| Save | 39 |
| Power Log PC Software | 40 |
| Installing Power Log Software..... | 40 |
| Starting Power Log..... | 40 |
| Using Power Log..... | 41 |
| Energy Recording with Fluke Power Log | 42 |
| Recording Power (Demand) with 1735 Power Logger..... | 44 |
| Inside the Logger..... | 45 |
| Line Power or Battery Mode | 45 |
| Replacing the Battery Pack | 46 |
| Maintenance | 47 |
| Calibration..... | 47 |
| Storage..... | 47 |
| Measurement Theory..... | 47 |
| Waveform..... | 48 |
| Power Measurements | 48 |
| Total Harmonic Distortion | 49 |
| Technical Specifications..... | 50 |
| General Information | 50 |

Contents *(continued)*

| | |
|--|----|
| Temperature ranges..... | 50 |
| EMC | 51 |
| Safety | 51 |
| Specifications..... | 51 |
| PF Power Factor..... | 53 |
| Frequency Measurement | 54 |
| Harmonics | 54 |
| Appendix A Values Recorded by the Power Logger | 57 |

List of Tables

| Table | Title | Page |
|--------------|---|-------------|
| 1. | Symbols..... | 2 |
| 2. | Standard Equipment..... | 4 |
| 3. | Optional Accessories..... | 4 |
| 4. | Maximum Possible Measuring Periods..... | 45 |

List of Figures

| Figure | Title | Page |
|---------------|---|-------------|
| 1. | Display Symbols | 6 |
| 2. | Control Elements..... | 7 |
| 3. | Power Logger Connectors..... | 8 |
| 4. | Menu Overview..... | 9 |
| 5. | Single Phase Connections | 21 |
| 6. | Split Phase Connections | 23 |
| 7. | Three-Phase Wye Connections | 24 |
| 8. | Three-Phase Delta Δ Connections..... | 25 |
| 9. | Fluke Power Log Screen..... | 41 |
| 10. | Fluke Power Log Displaying Three Phases of Voltage and Current | 42 |
| 11. | Replacing the Battery Pack | 46 |
| 12. | Flexi-probe Lock..... | 56 |

1735 Power Logger

Introduction

With this 1735 Power Logger (referred to throughout this manual as “Logger”) you can conduct voltage, current and power studies for determining existing loads. This information can be used for architecture or electrical inspector requirements in remodeling projects. The Logger is also a general-purpose power quality investigative tool that reveals the quality of voltage supply at any point in a distribution network.









The Logger was developed in particular for plant electricians and electrical installers, who have an important role in investigating and solving disturbances of the power distribution system.

Your 1735 Power Logger is equipped with Flash Technology. This enables you to perform firmware updates. Please use the Windows Flash Update utility to do this. You will find it on the supplied 1735 CD-ROM. If there is a firmware update, it can be found on the Fluke website: www.fluke.com.

Symbols

Table 1 lists the symbols used on the instrument and/or in this manual.

Table 1. Symbols

| Symbol | Description |
|---|---|
|  | Important information. See manual. |
|  | Hazardous voltage. |
|  | Earth ground. |
|  | Double insulation. |
|  | DC (Direct Current). |
|  | Conforms to requirements of European Union. |
|  | Canadian Standards Association is the certified body used for testing compliance to safety standards. |
|  | Do not dispose of this product as unsorted municipal waste. Contact Fluke or a qualified recycler for disposal. |
|  | Conforms to relevant Australian Standards. |

Safety Instructions

Please read this section carefully. It will make you familiar with the most important safety instructions for handling your Logger. In this manual, a **Warning** identifies conditions and actions that pose hazard(s) to the user. A **Caution** identifies conditions and actions that may damage the Calibrator or the test instruments.

Warnings

- **This Power Logger may only be used and handled by qualified personnel.**
- **To avoid electrical shock, remove all test leads from the Logger before you open the battery door. Open the Logger only to replace the rechargeable battery.**

- **Maintenance work must be done only by qualified service personnel.**
- **Use only specified current probes. If you use flexible current probes, wear suitable protective gloves or work on de-energized conductors.**
- **Protect the Logger against wetness and humidity.**
- **To prevent electrical shock, always connect voltage and current test leads to the Logger before connecting to the load.**
- **The plug and socket connection for the voltage lead set is designed for 600 V CAT III. The maximum voltage between outer conductor and earth potential must not exceed 600 V. With multi-phase connections, phase-phase voltage may not exceed 800 V.**
- **Use only the provided original or specified accessories. This includes the ac power adapter.**

Adequate qualifications are the following:

- Trained and authorized to switch on/off, ground (earth) and mark power distribution circuits and devices in accordance with the safety standards of electrical engineering.
- Training or instruction in accordance with the standards of the safety engineering in maintenance and use of appropriate safety equipment.
- Training in first aid.

Standard and Optional Accessories

The standard equipment for the Power Logger is listed in Table 2. Optional accessories are listed in Table 3.

Table 2. Standard Equipment

| Equipment | Model or Part Number |
|---|-----------------------------|
| Power Logger | FLUKE-1735 |
| Battery Charger, 115V/230V 50/60 Hz | BC1735 |
| International AC Power Plug Set For Battery Charger | 2441372 |
| Shielded 4-Phase Flexi Set for Models 1735, 1743, 1744, 1745 (15A/150A/1500A) | FS17XX |
| 4-Phase, 2 m Voltage Lead Set | VL1735 |
| Dolphin Clip, Black | 2540726 |
| Color Coding Wire Clips | WC17XX |
| Rechargeable Battery, NiMH 7.2V | 2625171 |
| Soft Case | 1642656 |
| CD ROM, FLUKE-1735 MANUAL AND SOFTWARE Includes: manuals, PC application software, firmware upgrade utility (English, French, German, Italian, Spanish, Portuguese, Chinese) | 2583487 |
| 1735 Users Manual (English only) | 2560330 |

Table 3. Optional Accessories

| Description | Accessory |
|--|-------------------|
| 3-Phase Flexi Set (15A/150A/1500A) | MBX 3FLEX |
| 3-Phase, 2 Meter Voltage Lead Set | MBX E438080005 |
| Current Clamps for Secondary CT taps, 1A/10A, 3-Phase, 2 m | MBX EP0450A |

Inspect the contents of the shipping box for completeness and damage. If there is any damage, report the damage to your shipper.

Software and Information CD

The CD delivered with the Logger contains additional, important information. This includes:

- International manuals
- Power Log PC application software
- 1735 Upgrade Utility for future Logger upgrades

Instrument Familiarity

Note

Please charge the battery before the first operation or use the provided charging adapter at the beginning.

Current Probes

Fluke flexi-sets or current clamps are automatically detected by the Logger when the Logger is turned on. If you change current probes, turn the Logger off and on again so the Logger can recognize the new probe.

Control Elements, Display

This section familiarizes you with the display and the controls.

Turn the Logger on by turning the rotary switch in clockwise direction. The display shows the selected measuring function.

Display Symbols

Figure 1 shows the display symbols the Power Logger uses.

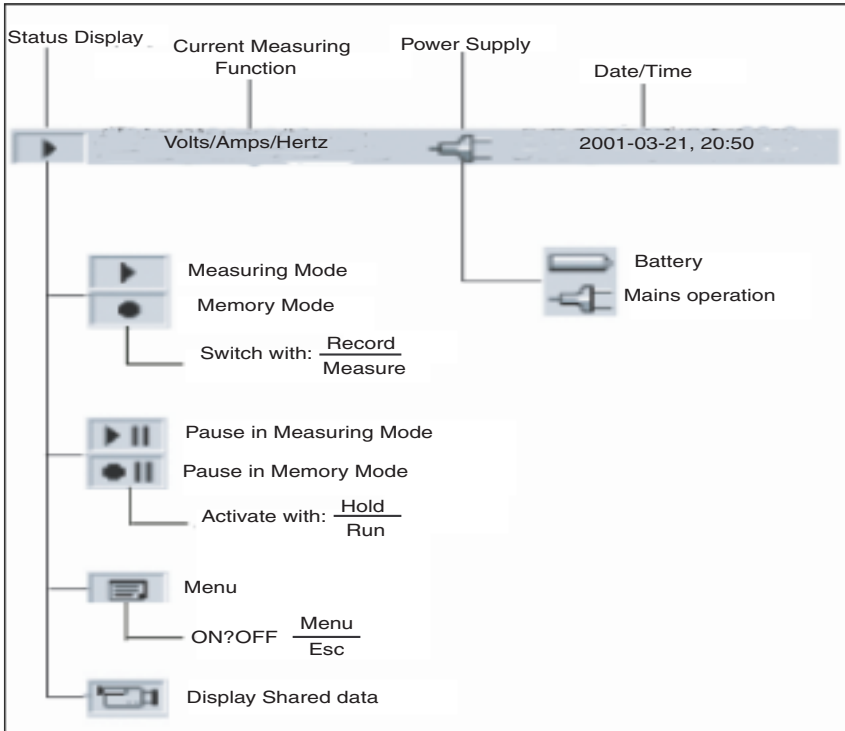

edx004.eps

Figure 1. Display Symbols

Description of the Control Elements

Figure 2 indicates the control elements of the Power Logger.

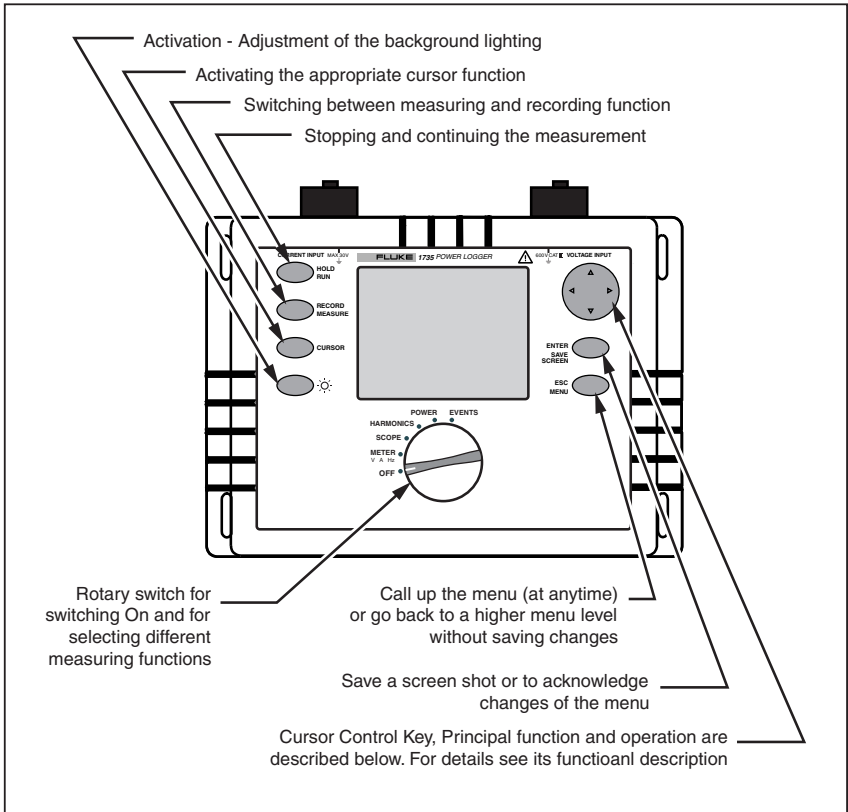

edx005.eps

Figure 2. Control Elements

Note

The symbols occurring in this operating instruction \triangle ∇ and \triangleleft \triangleright correspond to the respective directions of the cursor control keys.

Using the SAVE and CURSOR Keys

Pressing the ENTER/SAVE SCREEN key saves the current picture as a screenshot.

Since it is a screenshot, a saved picture cannot be modified or edited with the cursor.

The cursor control keys (◀ ▶ △ ▽) are activated once you are in *HOLD* mode.

Pressing the CURSOR key starts cursor mode. Press ◀ and ▶ to move the cursor and read the current values on the display.

Pressing the CURSOR key in the recording mode sets a reference cursor.

Screenshots can also be taken in cursor mode.

Pressing ESC exits cursor mode and returns to the hold mode.

Connectors

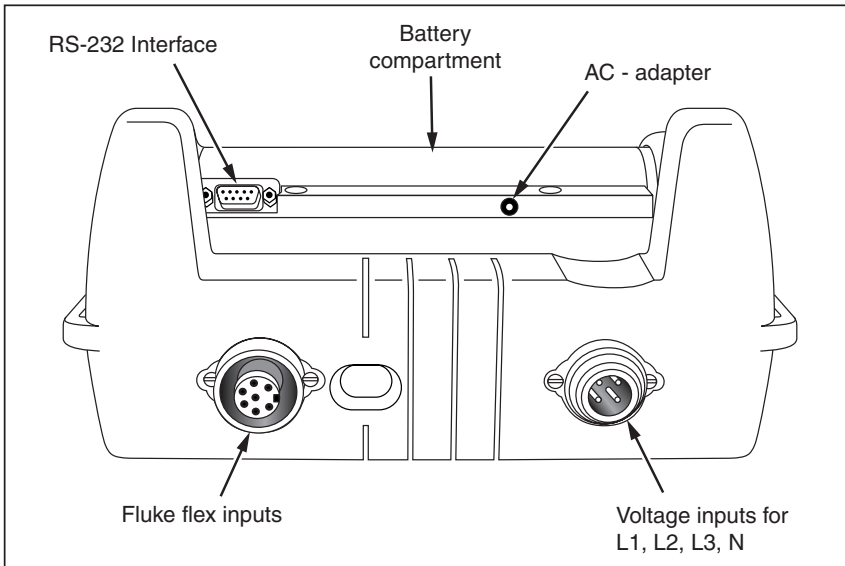

Figure 3. Power Logger Connectors

edx006.eps

RS-232 Interface

The serial RS232 interface is used for communication with an external PC. Use Power Log software (included) to download and analyze logged data. This interface is also used for updating firmware using the 1735 Upgrade Utility.

Basic Adjustments (Menu)

Menu Structuring

You make all basic adjustments of the Logger in the main menu. You can call this at any time with the key . If you push it again you return to the previous display.

Short Overview of the Menu

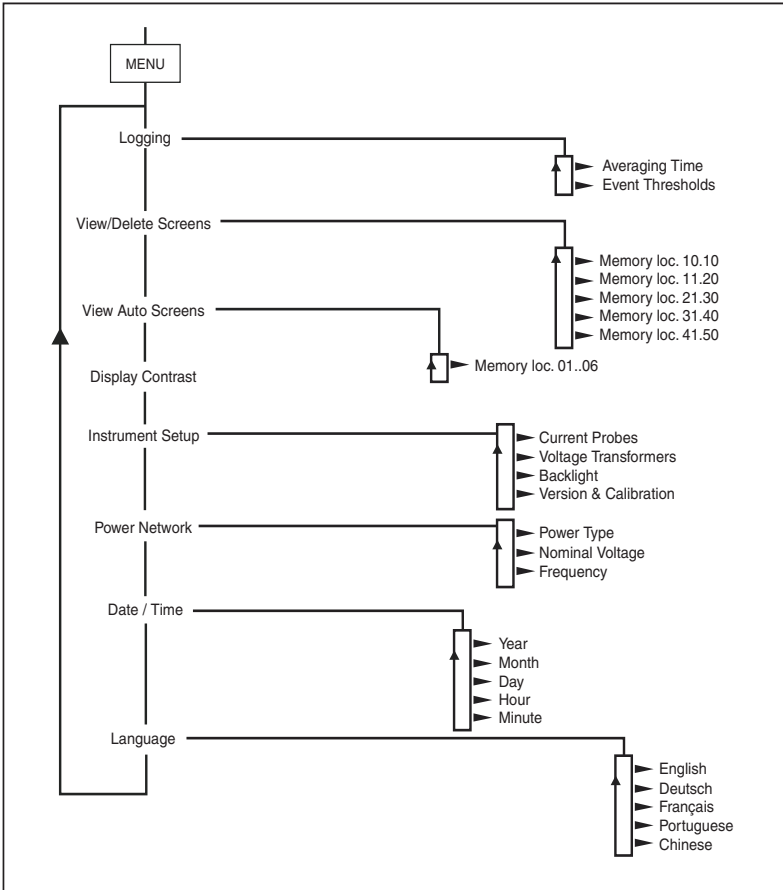

edx007.eps

Figure 4. Menu Overview

Parameter Configuration

Logging Menu

If you call the logging menu, then you can select between two further submenus: Menu for adjusting the averaging time and for adjusting the event threshold in recording adjustments.

In the menu *Averaging* you select the time over which the data are to be averaged. You can also select these values from the predefined values for averaging time. As you change the averaging time, you will see on the display the resulting logging time available for each averaging interval.

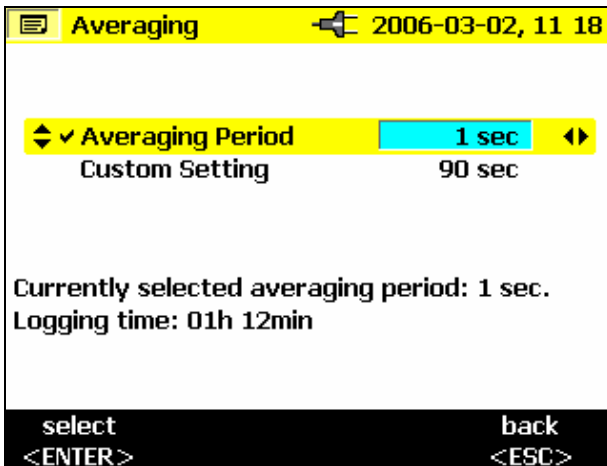

edx009.bmp

With *Custom Setting* you can choose any averaging time value. Depending on the selected averaging time, maximum available recording time is indicated in the display at the same time. Up to 4,320 averaging intervals can be recorded with the record function.

By selecting the menu *Event Thresholds* you can select the threshold voltage at which the recording is to be started (see also ‘Harmonics’).

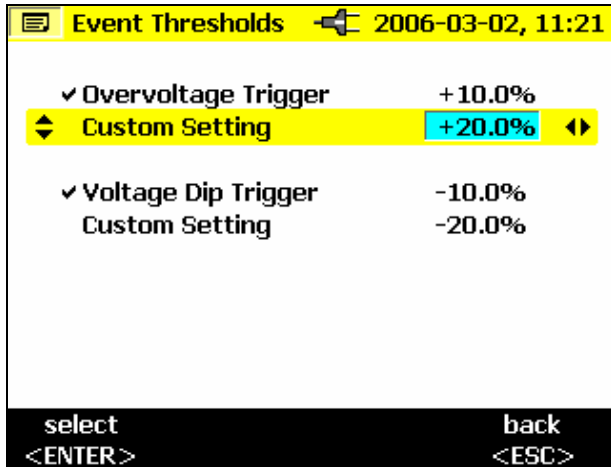

edx010.bmp

View/Delete Screenshots

Select one of the saved screenshots. Press *ENTER* to view it. All screenshots include the date and time and the measuring mode, in which they were saved. Each page lists 10 events.

Use the ◀▶ to change the page.

| View/Delete | | 2006-03-02, 12 47 |
|-------------|------------------|-------------------|
| 1 | Volts/Amps/Hertz | 2006-03-02, 11:25 |
| 2 | Scope | 2006-03-02, 11:25 |
| 3 | Scope | 2006-03-02, 11:25 |
| 4 | Scope | 2006-03-02, 11:25 |
| 5 | Scope | 2006-03-02, 11:25 |
| 6 | Harmonics | 2006-03-02, 11:26 |
| 7 | Harmonics | 2006-03-02, 11:26 |
| 8 | Harmonics | 2006-03-02, 11:26 |
| 9 | Harmonics | 2006-03-02, 11:26 |
| 10 | Harmonics | 2006-03-02, 11:26 |
| view | delete | del. all |
| <ENTER> | <CURSOR> | <HOLD> |
| | | back |
| | | <ESC> |

edx011.bmp

View Auto Screenshots

With this menu item, you can view the screenshots of a recording session, which have been automatically saved in the Save mode. 6 screenshots are available (01 to 06).

Select one of the pictures with the cursor key and press *ENTER* to view it.

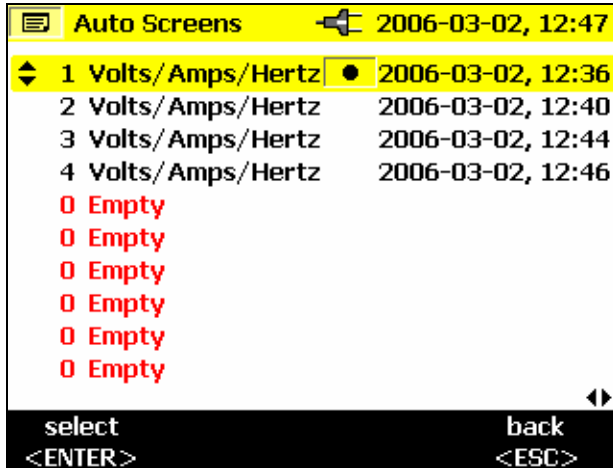

edx012.bmp

Note

Saved Auto Screenshots always show the currently displayed parameters.

Example: If you selected phase L2 in the Volt/Ampere/Hertz function and the recording reaches the margin of the picture, a screenshot of the current picture, i.e., phase L2, is saved.

Display Contrast

Select the display contrast optimal for you with $\triangle \nabla$.

Instrument Setup

In this menu option you can make adjustments in the submenu for:

- Current Probes
- Voltage Transformers
- Phase Identification
- Backlight
- Version and Calibration

These are described individually in the following:

Current Probes

When a Flexi set or Current Probe is connected to the instrument it is automatically recognized, but only at power-up. Select the current measuring range by pressing \leftrightarrow . If the secondary of a current transformer is being measured, it is possible to display the current in terms of the primary by entering a CT ratio into the current probe setting.

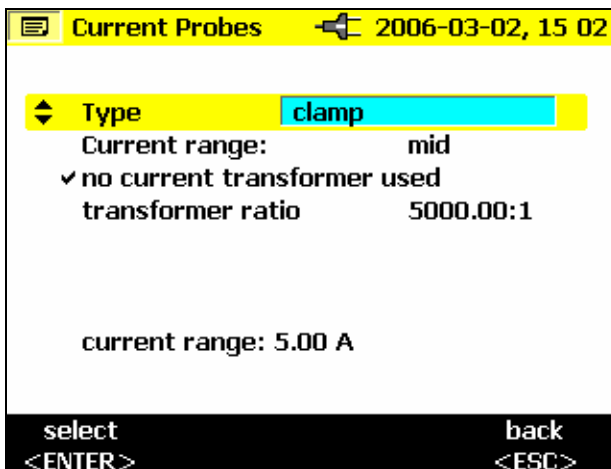

Use \triangle / ∇ to select *transformer ratio*

Use \triangleleft / \triangleright to enter the ratio

edx013.bmp

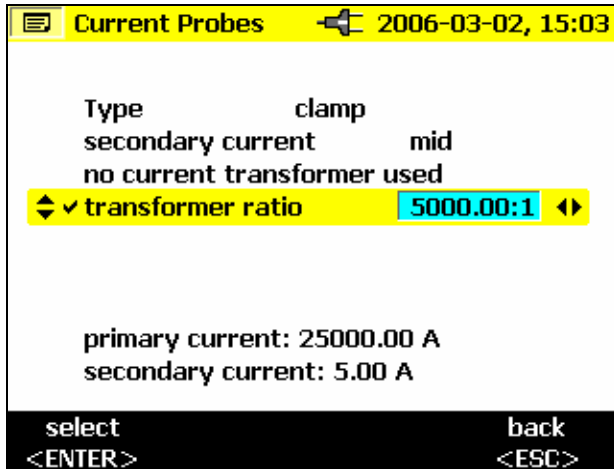

edx014.bmp

Use $\triangleleft \triangleright$ to select digit and $\triangle \nabla$ to adjust the value

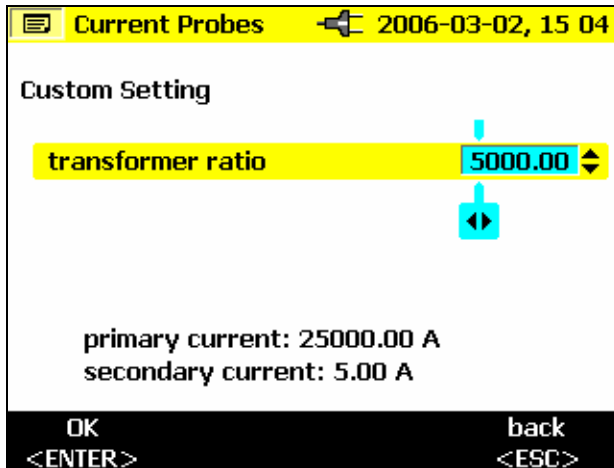

edx015.bmp

The effect of the ratio is shown at the foot of the display with the primary of the interposing transformer displayed above the secondary current (input to probe).

Press *ENTER* to confirm changes.

Voltage Transformers

If you use voltage transformers, select transformation ratio with *ENTER*. Press the ◀▶ key and enter any transformation ratio with △▽.

For transformation ratio details see information on the *voltage transformer*.

Phase Identification

Here you can choose whether the display shows “A, B, C” for phase identification or “L1, L2, and L3.” In this manual, phases are called A, B, and C, but this is equivalent to L1, L2, and L3.

Backlight

This selects whether the backlight deactivates automatically after 30 seconds or whether you want to always deactivate it manually after you turn it on with the ✱ key.

Note

If the battery is in use, use the backlight only if necessary in order to conserve battery life.

Version & Calibration

This menu serves for your information. No adjustments can be made. The displayed data give information of type and version of the logger firmware.

Power Network

Select the Power Type (Single phase, split phase, wye, 2-element delta, 3-element delta), here. This is also where you select the nominal phase voltage and frequency.

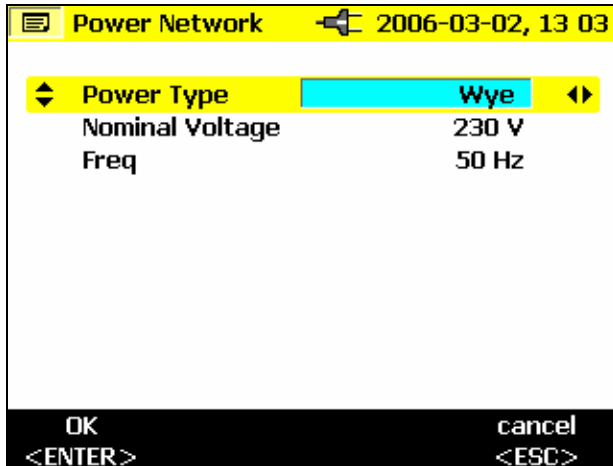

edx016.bmp

Date & Time

Here you can enter the current date and the current time.

Language

Presents a menu of the provided languages for the Logger displays.

Measuring Functions

Overview

The following information provides an overview of each rotary switch position.

Meter Volts / Amps / Hz

This function displays the voltage and current values at the same time, plus the frequency and the neutral-conductor current. You can also use this measuring function to get an overview of these values before you analyze the signal in detail in the other functions.

Scope

Scope shows the voltages, currents and the φ (phase) angle in oscilloscope representation as well as their instantaneous values at the cursor position. With this function you get a clear picture of current and voltage waveforms and their distortions.

Harmonics

Harmonics are sinusoidal voltages with a frequency that corresponds to an integer multiple of the fundamental (line) frequency.

Every signal can be split into an infinite number of sine waves of different frequency and amplitude. The contribution of each of these individual sine waves is represented in a bar chart up to the 40th harmonic. The smaller the harmonics are (starting from the 2nd harmonic, the 1st is the fundamental) the better is the power network quality.

Power

This function indicates the values of the transferred power. At the same time you can measure active power, reactive power, apparent power, distortion power and the appropriate power factor. You can also view the active and reactive power energy.

Note

Demand can be logged by setting the averaging period in the Setup menu to either 10 or 15 minutes, which produces a record of consecutive averages. This is called block demand.

Events

Events are voltage dips, swells and interruptions. This measuring mode automatically records all events for later evaluation. The threshold values for starting the recording are freely configurable in the menu.

Connecting the Power Logger to the Network

⚠ ⚠ Warning

To prevent the risk of electric shock, when connecting current circuits, the corresponding test leads must first be connected to the Logger and then to the load.

Use the original cables only for connecting the current probes and the voltages to the Logger. If these are damaged do not use them. Before connecting to the load, make sure that all plugs are connected correctly to the Logger and locked, in order to prevent contact with live conductors.

Color Coding Wire Clips

Your Logger includes a set of color clips that you can attach to the test leads. These help you keep track of which current probe lead and voltage lead belongs to which phase. The large clips are for the current probe leads and the small clips are for the voltage leads. Use the plastic rod tool to help you attach the clips.

Single and Split Phase Connections

For Single Phase + Neutral, refer to Figure 5 and connect the leads as follows:

Voltage:

| Network | Test Leads |
|----------------|-------------------|
| Line | A (L1) |
| Line (same) | B (L2) |
| Line (same) | C (L3) |
| N | N |

Current:

| Network | Test Leads |
|---------------|------------|
| L1 | A (L1) |
| Not connected | B (L2) |
| Not connected | C (L3) |
| Not connected | N |

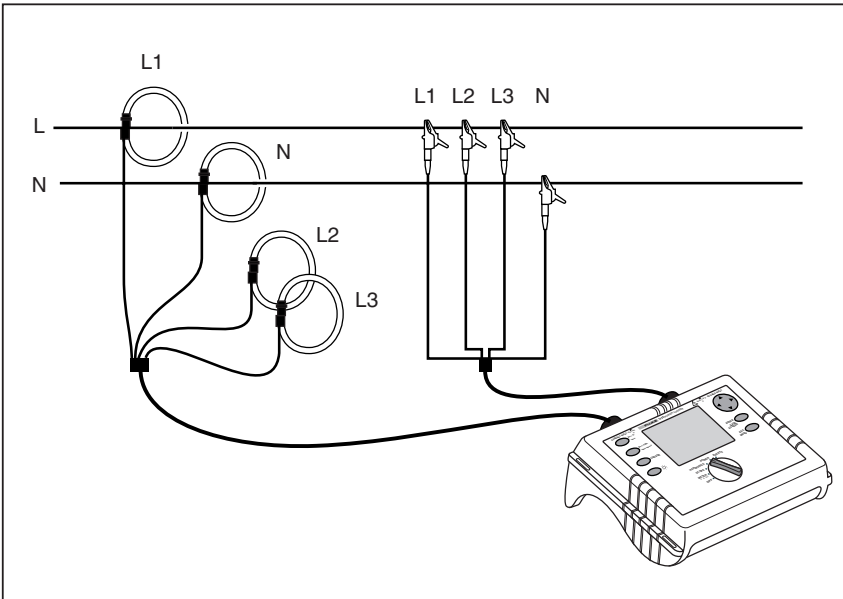

Figure 5. Single Phase Connections

edx040.eps

Split Phase

For Split Phase, the Neutral is center-tapped and there are two hot legs which correspond to A and B test Leads. AB is the voltage from phase to phase, which is twice that of each individual hot leg. Refer to Figure 6 and connect the leads as follows:

Voltage:

| Network | Test Leads |
|----------------|-------------------|
| Line 1 | A (L1) |
| Line 2 | B (L2) |
| Line 1 | C (L3) |
| N | N |

Current:

| Network | Test Leads |
|-----------------------|-------------------|
| A (L1) | A (L1) |
| B(L2) Line 1 | B (L2) |
| Not connected Neutral | C(L3) |
| N | N |

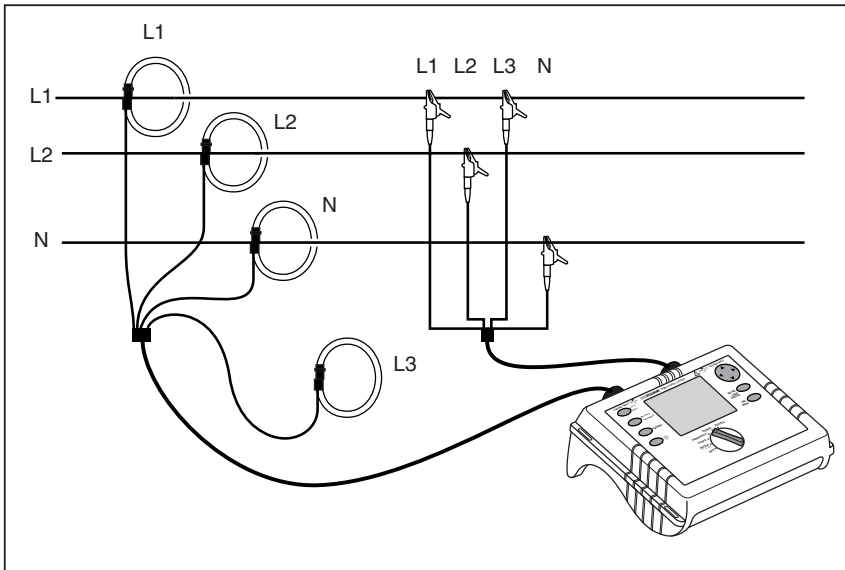

edx041.eps

Figure 6. Split Phase Connections

Measurement in a Three-Phase Power Network

In order to measure all phases in the three-phase power network with the Logger you attach your Logger to the measuring power network according to the following figures.

See 'Power' for further details.

Voltage:

| Mains Line | Test Leads |
|------------|------------|
| A (L1) | A (L1) |
| B (L2) | B (L2) |
| C (L3) | C (L3) |
| N | N |

Current:

| Mains Line | Test Leads |
|------------|------------|
| A (L1) | A (L1) |
| B (L2) | B (L2) |
| C (L3) | C (L3) |
| N | N |

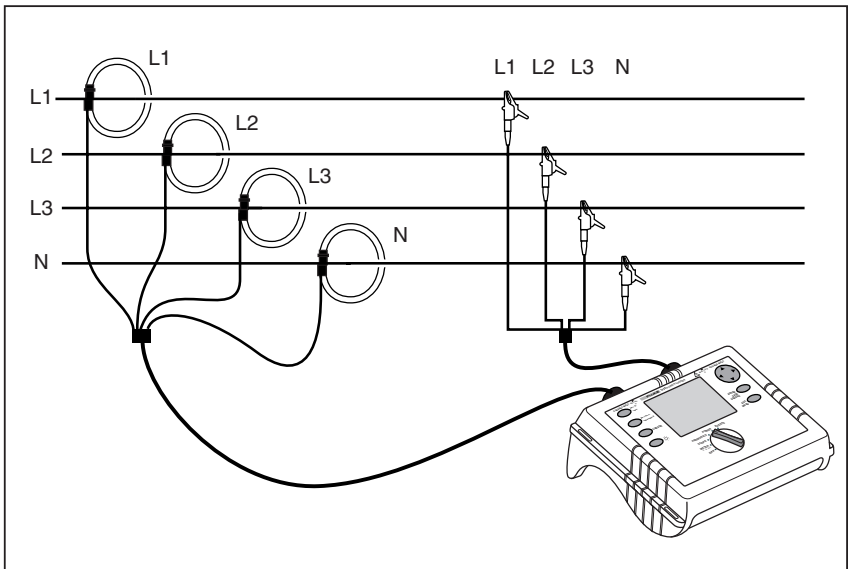

edx042.eps

Figure 7. Three-Phase Wye Connections

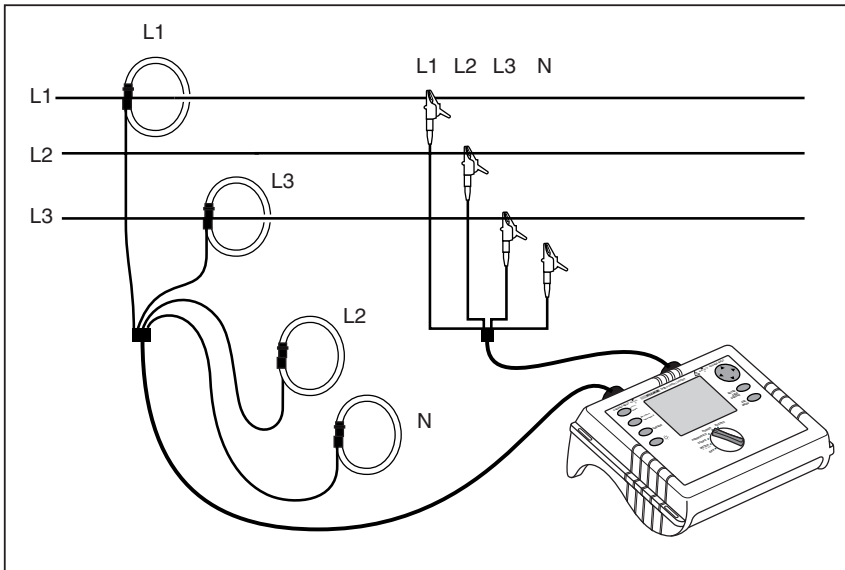

edx043.eps

Figure 8. Three-Phase Delta Δ Connections

Volts / Amps / Hertz

Select Meter with the rotary switch.

In this mode you can measure values for each phase (A, B, C) of

- Voltage (V)
- Current (I)
- Frequency (F)
- Neutral-conductor current (In)

You can determine and store the values. It is also possible to log the values with the logging function.

Measurement or calculation of the neutral-conductor current is optional.

Logging

In Logging mode, the following values are recorded for every phase (A, B, C)

- Voltage (V) and

- Current (I) and the value of the
- Frequency (F)

These values can be recorded in the instrument, downloaded and evaluated with the *Fluke Power Log* software package

Measurement

If you select this measuring mode you will see the following display:

| | V rms | A rms |
|----|-------|-------|
| L1 | 109.9 | 10.32 |
| L2 | 109.9 | 10.43 |
| L3 | 109.9 | 10.31 |

edx024.bmp

- △▽ Use this switch to get the following values:
 - minimum of values
- ◁▷ - maximum of values and
 - frequency or neutral-conductor current

With *Hold/Run* the actual values “freeze” and the measurement is stopped or started again.

Save

With *Save/Enter* you will get a screenshot and thus store the actual picture of the display in the memory location subsequently shown.

Logging Function

With *Record/Measure* you can start the logging function or you can get back into the measuring mode. Before the start, the maximum logging time is indicated and you can change this value with *Esc* followed by entering using the *Cursor* key.

Changes in the averaging time, cause corresponding changes in the logging time of the measurement (double averaging time = double logging time).

When the logger graphics reach the screen margin during recording, a picture of this screen is saved.

The display is then deleted and the recording is continued. Up to 6 auto screens are saved in the course of a recording. The saved screenshots can be retrieved via the *View Auto Screenshots* menu.

Note

Do not forget to operate the Logger with the AC adapter during logging in order to prevent shutdown caused by low battery.

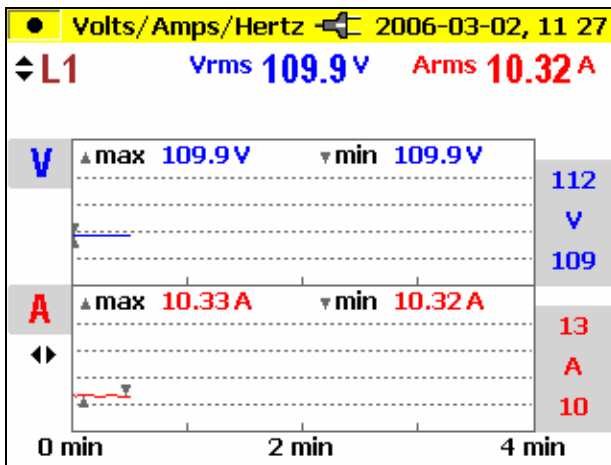

edx025.bmp

- △▽ Select between the individual phases
- ◁▷ Select between the two representation modes:
 - V and I (see fig.)
 - V and F
 - V and In

Analyzing the measured values of the recorder function:

Use of the key *cursor*. When you invoke the cursors you can probe the graphs and display the associated values. With \triangle ∇ you can select the individual phases again.

Note

The Cursor functions are only available in the “Hold” mode.

These values can be recorded in the instrument, downloaded and evaluated with *Fluke Power Log* software package.

Power

Select Power with the rotary switch.

In this measuring mode you can get the following values for each phase (A, B, C):

- Power (P) in W (for each phase and its sum P_{tot}).
- Reactive power (Q) in var (for each phase and its sum Q_{tot}).
- Apparent power (S) in VA (for each phase and its sum S_{tot}).
- Distortion power (D) in VA (for each phase and its sum D_{tot}).
- Power factor (PF) and the average PF for the three phases.
- $\cos \varphi$ and the average $\cos \varphi$ for each of the three phases.
- Active energy (EP) in kWh.
- Reactive energy (EQ) in kVAR.

Measurement

You can determine the instantaneous values and store them. You can also record the values with the recorder function.

If you select this measurement mode you will get the following display:

| Power | | 2006-03-02, 13 18 | |
|---------------------------------------|-------|----------------------|----------------------|
| L ¹²³ 8.378 _{tot} | | 12.44 _{tot} | 0.672 _{tot} |
| kW | | kVA | PF |
| L1 | 2.780 | 4.128 | 0.673 |
| L2 | 2.826 | 4.193 | 0.673 |
| L3 | 2.772 | 4.120 | 0.672 |

edx026.bmp

△▽ Switch between the individual phases (detailed view: min- max- values and distorted power and Energy values).

◁▷ Switch between the representation modes:

- P, S and PF
- P, S and Q
- P, S and D
- P, S and EP
- P, S and EQ
- P, S and $\cos\phi$

On pressing △▽ the accumulated energy function becomes active, this must be acknowledged by pressing *RUN* to activate the accumulation timer.

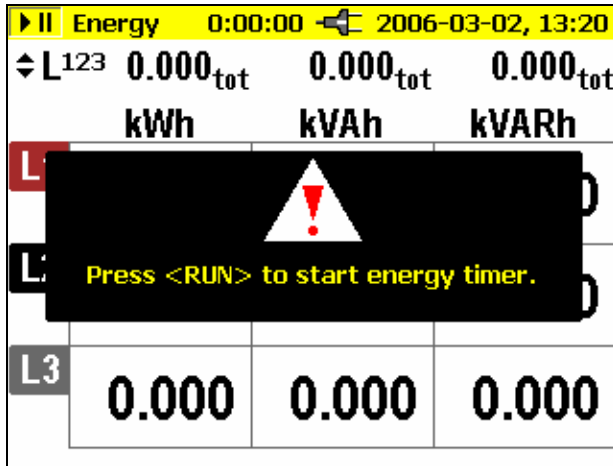

edx027.bmp

The accumulation time is indicated at the top of the measurement display.

A further press of $\triangle \nabla$ gives a detail view of the individual phase values.

Capacitor or inductance symbols issue information about capacitive or inductive reactive power.

With *Hold/Run* the values displayed at the moment “freeze” and the measurement is stopped or started again.

Note

In the individual representation of A or B or C, the active and reactive energy cannot be selected.

Three-Phase Power Theory

By switching the Power Network setting from wye to delta, the voltages and currents I_{L1} , I_{L3} , I_{L2} are calculated, measured and displayed.

When calculating the power, selecting the delta connection will use the two-wattmeter method (Blondel or Aron) measuring circuit for the calculation.

The neutral conductor may be connected, however, it does not influence the measurement even in open state. If no neutral conductor is connected, a virtual “metering neutral” is established in the Logger via symmetrization resistors.

In the Blondel (or Aron) circuit, phase L2 becomes the return line for L1 and L3 causing the current I_{L2} to be obtained as the sum of the two negative currents I_{L1} I_{L3} .

$$i_2(t) = -[i_1(t) + i_3(t)]$$

In general, the instantaneous total power is:

- $P_{tot}(t) = v_1(t) i_1(t) + v_2(t) i_2(t) + v_3(t) i_3(t)$
- $P_{tot}(t) = v_1(t) i_1(t) - v_2 [i_1(t) + i_3(t)] + v_3(t) i_3(t) =$
 $= [v_1(t) - v_2(t)] i_1(t) + [v_3(t) - v_2(t)] i_3(t)$

However, since the voltages between the lines of a poly-phase are measured in the delta connection, the following formula results for the total power:

$$P_{tot}(t) = v_{12}(t) i_1(t) + v_{32}(t) i_3(t)$$

Integration via a period results in:

$$P_{tot} = V_{12} I_1 \cos(V_{12}, I_1) + V_{32} I_3 \cos(V_{32}, I_3)$$

Therefore, the total power corresponds to the total power of the Wye connection. For control purposes, it can be derived from the sum of the powers P_{12} and P_{31} .

Since I_{L2} is only calculated as an auxiliary value and is not measured, P_{23} must be set to zero (as per definition), because it does not exist in the Aron circuit.

The power factor PF has no physical meaning in the Aron circuit, because one would compare the current to the voltage between the lines of a poly-phase system. Reactive and apparent power should be understood as pure computing values and have no physical meaning.

Invalid measurements are suppressed from the display by the symbol '----'.

The exact formulae for calculating the active power are given in the section Measurement Theory.

Save

With *Save/Enter* you will get a screenshot and thus store the actual display in the memory location shown subsequently.

Logging Function

With *Record/Measure* you can start the logging (recorder) function or you can get back into the measuring mode. Before the start, maximum recording time is indicated and you can change this value with cursor.

Changes in the averaging time, cause corresponding changes in the recording time of the measurement (double averaging time = double recording time).

When the recorder graphics reach the screen margin during recording, a picture of this screen is saved.

The display is then deleted and the recording is continued. Up to 6 auto screens are saved in the course of a recording. The saved screenshots can be retrieved via the *View Auto Screenshots* menu.

Note

Do not forget to operate the Logger with the BC 1735 AC Power Adapter during recording in order to prevent shutdown caused by low battery.

Active and reactive energy are not shown in the recorder function.

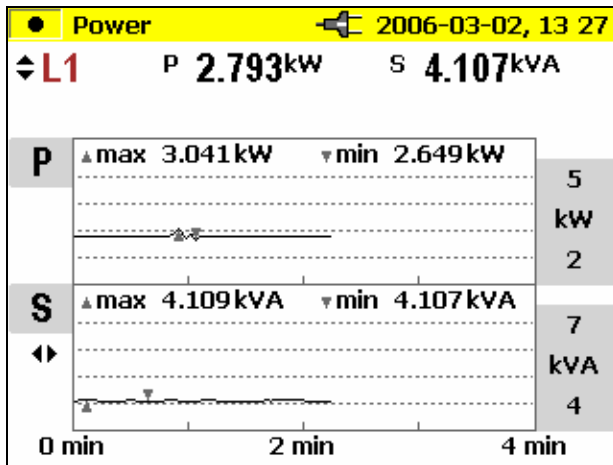

edx028.bmp

- $\triangle\nabla$ Switch between the individual phases
- $\triangleleft\rangle$ Switch between the representation modes:
 - P and Q
 - P and S
 - P and PF
 - P and $\cos \varphi$
 - P and D

Analyzing the measured values of the recorder function:

Use of the key *cursor*. When you invoke the cursors you can probe the graphs and display the associated values. With $\triangle\nabla$ you can select the individual phases again.

Logging

In the Logging (Record) mode, the following values are recorded for every phase (L1, L2, L3)

- Active power (P)
- Apparent power (S)
- Reactive power (Q)
- Power factor (PF)
- Cosine ($\cos\varphi$)
- Distortion power (D)
- Accumulated values (kWh, kVAh, kVARh)

These values can be recorded in the instrument, downloaded and evaluated with *Fluke Power Log* software package.

Note

The cursor functions are only available in the Hold mode.

Events

Select Events with the rotary switch.

This measuring mode records the voltage of every phase (L_1 , L_2 , L_3) in cases of voltage dips, swells or interruptions (recorder function).

This function exclusively works with the recorder function.

Before you start the measurement, select the desired threshold value with *Menu/Esc* (under recording adjustments). After the measurement has started the following message appears on the display.

. . . waiting for events

The Logger is now in the trigger mode. If an event on one of the phases occurs, the recording is started automatically and lasts for 4 minutes. The MIN and MAX values of the half-cycle RMS values are shown as waves. The screenshots recorded by this method are saved as individual pictures and can be viewed later, or the data can be displayed with the *Power Log* software. A total of 999 events can be recorded. In the LC display the phase and the number of recordings are displayed.

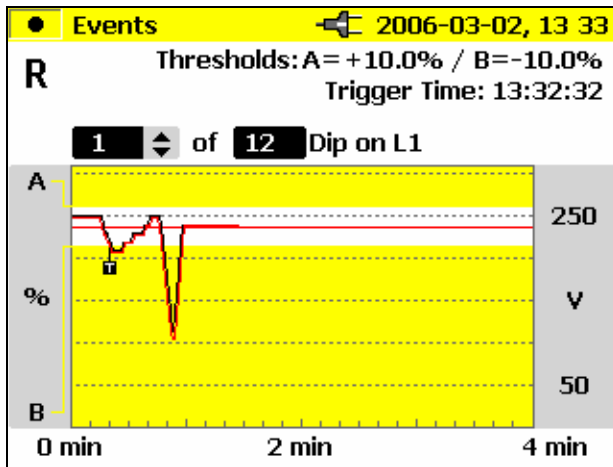

edx029.bmp

△▽ Switch between the individual events (if there is more than one).

This is also possible if the recording has been stopped and you want to evaluate the stored events.

With *Hold/Run* you can stop/start the measurement or you can also start a new measurement.

Save

With *Save/Enter* you will get a screenshot and thus store the actual display in the memory location shown.

Logged Events

You can download logged events using *Fluke Power Log* software package.

The *Fluke Power Log* software presents the event data in a variety of formats:

- graphs similar to those displayed on the instrument
- statistical format with number of events, range of duration and range of voltage
- spreadsheet format with date/time stamp, event type and duration

Harmonics

Select Harmonics with the rotary switch.

In this measuring mode you can determine the Harmonics H1 (fundamental frequency) to H40 for all phases (L1, L2, L3) of:

- Voltage (V)
- Current (I)

Measurement

When selecting this measuring mode with the rotary switch the harmonics are immediately and clearly represented on the LC display as follows:

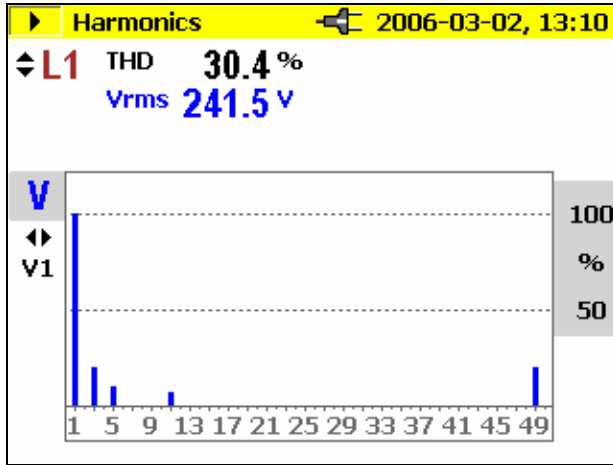

edx030.bmp

△▽ Switch between the individual phases.

◁▷ Switch between V and I.

With *Hold/Run* the values displayed at the moment “freeze” and the measurement is stopped or started again. By pressing the cursor key, you will go into cursor mode, where you can read additional values of the individual harmonics. With △▽ you can select the individual harmonics. Once the cursor mode is activated, the scale can be changed with the ◁▷ from 100 %-50 % to 50 %-25 % or 10 %-5 %.

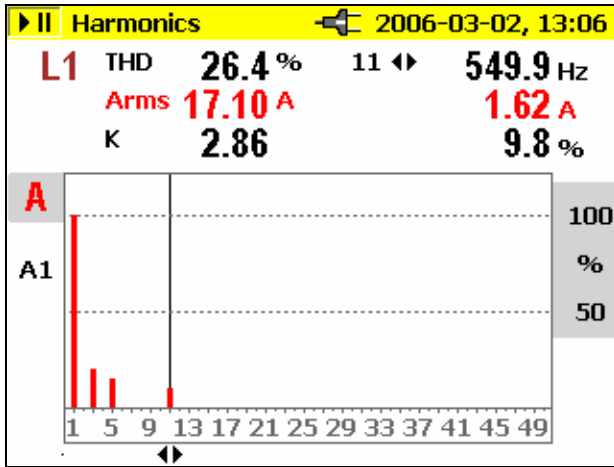

edx031.bmp

Logger Function

Record/Measure starts the logging function or toggles from logging to measurement mode, respectively.

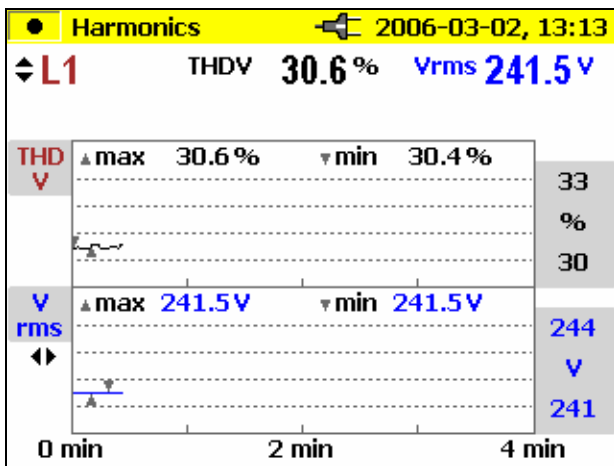

edx032.bmp

△▽ Switching between individual phases

◀▶ Switching between V and I

When the recorder graphics reach the screen margin during recording, a picture of this screen is saved.

The display is then deleted and the recording is continued. Up to 6 auto screens are saved in the course of a recording. The saved screenshots can be retrieved via the *View Auto Screenshots* menu.

You can exit a measurement with *HOLD*, however, the measurement cannot be continued afterwards. In order to evaluate the measurement values of the recorder function:

Use the *Cursor* key. Using the cursor control keys, select the respective time and read the corresponding measurement value.

Logging

In Logging mode, the following values are recorded for every phase (L1, L2, L3)

- Voltages (V) and
- Currents (I)
- THD V
- THD I
- Values of uneven harmonics from 1-25 for V and I
- Frequency

These values can be recorded in the instrument, downloaded and evaluated with *Power Log* software package

Save

With *Save/Enter* you will get a screenshot and thus store the actual display in the memory location shown subsequently.

Scope

Select Scope with the rotary switch.

In this measuring mode you get a live picture of the waveforms of

- Voltage (V)

- Current (I)
- Angle (φ)

for all three phases (L1, L2, L3).

Measurement

If you select the measuring mode with the rotary switch the following figure appears on the display. The three phase voltages and current values are plotted for the time of one period.

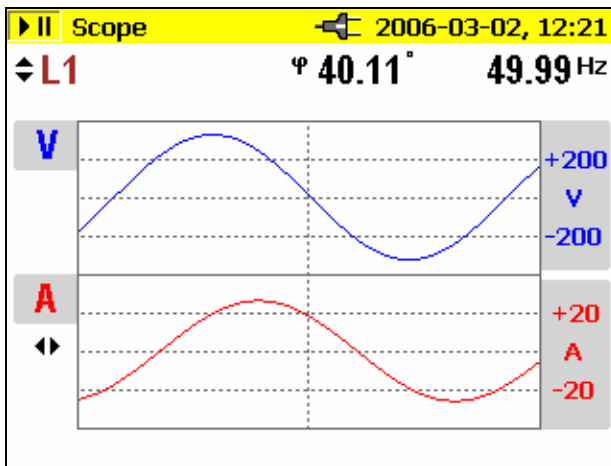

edx033.bmp

△▽ Switch between the individual phases or total view of all phases (as shown in figure).

◁▷ While viewing the individual phases, the cursor can be shifted and the value at this location is displayed.

In the individual view, the φ angle is also shown.

With *Hold/Run* the momentary values “freeze” and the measurement is stopped or started again.

Save

With *Save/Enter* you will get a screenshot and thus store the actual display in the memory location shown subsequently.

Note

In this mode the recorder function is not available.

The angle (φ) describes the phase shift between first harmonic active power and first harmonic reactive power. See formula in the Measurement Theory section for more details.

Power Log PC Software

Power Log provides data download, analysis and reporting in one simple to use package.

Installing Power Log Software

Insert the supplied CD-Rom, the main menu starts automatically (if it doesn't double-click on "setup.exe" and execute the program). Please follow the instructions appearing on the screen (menu):

Power Log is a simple but complete application designed to help the user get the most from the 1735 Power Logger,

Check www.Fluke.com for any available new releases.

Starting Power Log

1. Click the Start button.
2. From the start menu, point to programs, point to Fluke Power Log then click *Fluke Power Log*.

For 3 seconds there is a screen that identifies the program:

Then your screen will look similar to this:

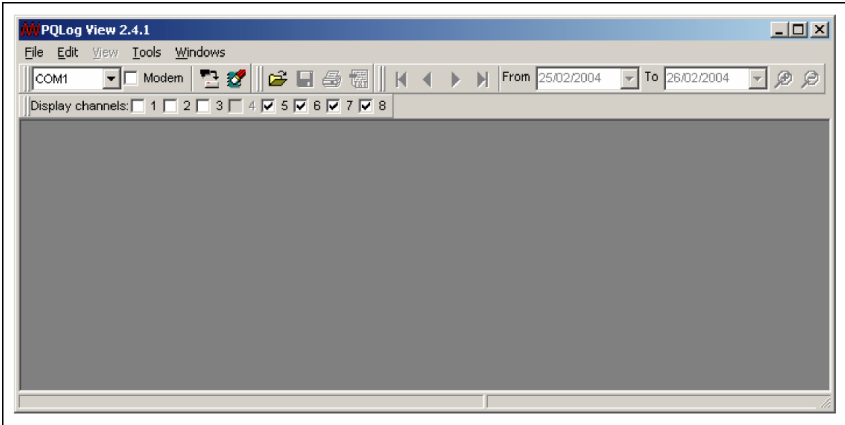

edx034.bmp

Figure 9. Fluke Power Log Screen

Fluke Power Log incorporates several toolbars which provide quick access to commonly used functions. These functions are also accessible from the Menu Bar. All toolbars can be re-arranged by dragging them, or make them ‘float’ over the application. It is also possible to hide them by clicking the ‘x’ button when ‘floating’.

Using Power Log

Primary functions:

- The Download data button. A connection will be established with the 1735 Power Logger, and all Logger recordings will be downloaded.
- The *Main Toolbar* also comprises of 4 items, but only 1 is active at start-up:
 - Open data from File: To retrieve previously saved data files from the PC hard drive.
- The other 3 buttons are active when the *Fluke Power Log* has data stored in memory:
 - Save data to File.
 - Print Current Screen.

- Print report. This produces a printed report of the information on screen. It is possible to adjust the report parameters to avoid the printing of data not required and the generation of large reports.

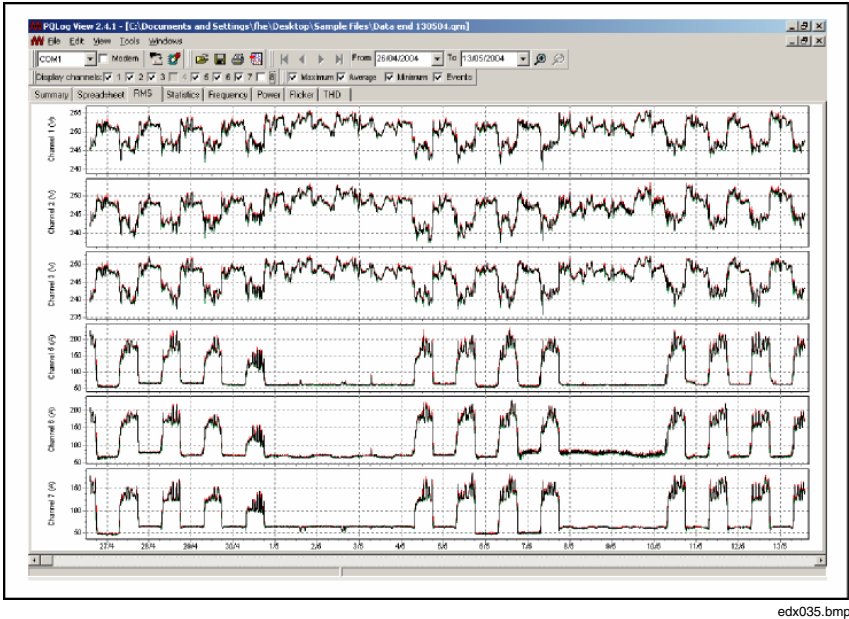

Figure 10. Fluke Power Log Displaying Three Phases of Voltage and Current

In the *Power Log*, every file has its own window within the main one. This allows files to be open simultaneously for comparison. Each of these windows has tab markers, which are used to select different viewing modes of the recorded data.

Energy Recording with Fluke Power Log

The supplied software *Fluke Power Log* enables analysis of energy data in two modes.

The first mode shows the energy as an incremental graph:

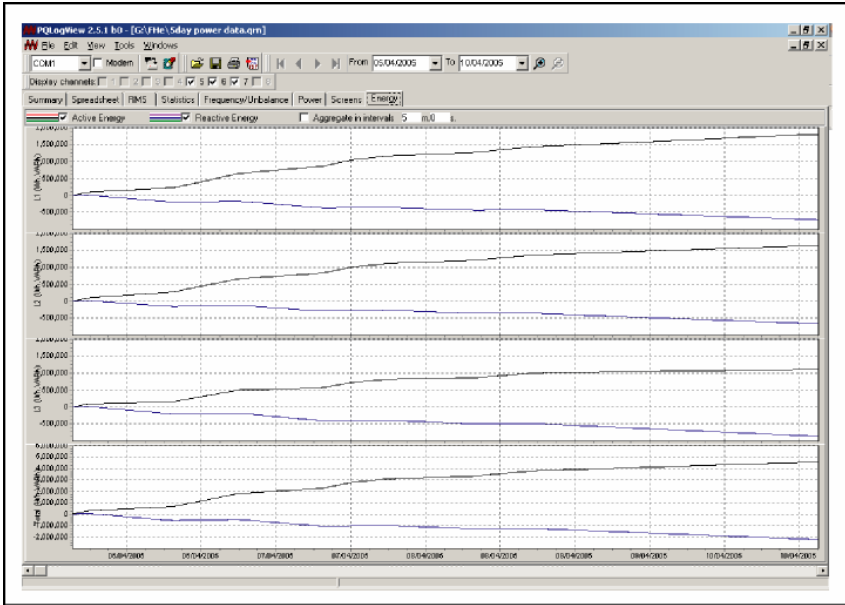

edx036.bmp

The second mode allows a time aggregation period to be set. The minimum aggregation time is the same as the recorded average period. Values greater than the recorded period may also be set.

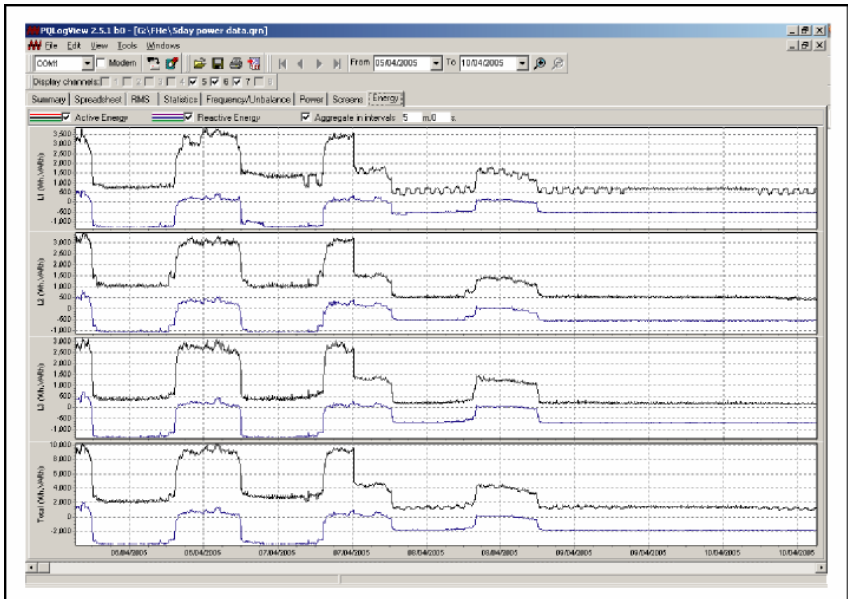

edx037.bmp

Recording Power (Demand) with 1735 Power Logger

This section provides an example of using the logging function to record 15-minute demand averages over 30 days. However, this is only one example of the types of recordings that you can make.

The export of events is an exception, which is described separately in “Using Power Log.”

- Connect Logger to the power network at switchgear, a junction box, or breaker panel, or other convenient access point; set up for POWER.
- Start the measurement by pressing Record.
- In the POWER switch position,, Logger can record up to 4,320 intervals based on the preset interval time. The process can be cancelled by pressing RECORD/MEASURE at any time.

Table 4. Maximum Possible Measuring Periods

| Measurement Function | Average Interval | Recording Time |
|--------------------------------|-------------------------|-----------------------|
| V/A/Hz, Harmonics, Power | 1 sec | 1 hour, 12 minutes |
| | 2 sec | 2 hours, 24 minutes |
| | 5 sec | 6 hours |
| | 10 sec | 12 hours |
| | 30 sec | 1 day, 12 hours |
| | 1 min | 3 days |
| | 5 min | 15 days |
| | 10 min | 30 days |
| | 15 min | 45 days |

Inside the Logger

Line Power or Battery Mode

You can operate the Logger continuously with the provided charging adapter or for a few hours with the built-in battery. The battery is to ride through power interruptions during logging sessions, and to provide operating power during handheld troubleshooting and analysis of signals.

If you operate your Logger with the ac adapter, the battery is charged automatically. On the display the symbol for “plugged-in” or battery is displayed accordingly.

If the battery is completely discharged, it takes about 4 hours to charge it completely. It is impossible to overcharge the battery as the Logger has an automatic charging circuit.

When LO-BAT is indicated, attach the ac adapter to recharge the battery.

Replacing the Battery Pack

If the battery life is noticeably low (see technical specification), then it has to be replaced. Replace the battery as follows:

1. Turn off the Logger
2. Disconnect all measuring leads
3. Open the battery compartment (two cross-notched screws)
4. Unplug and replace the battery pack. Close the battery compartment again.

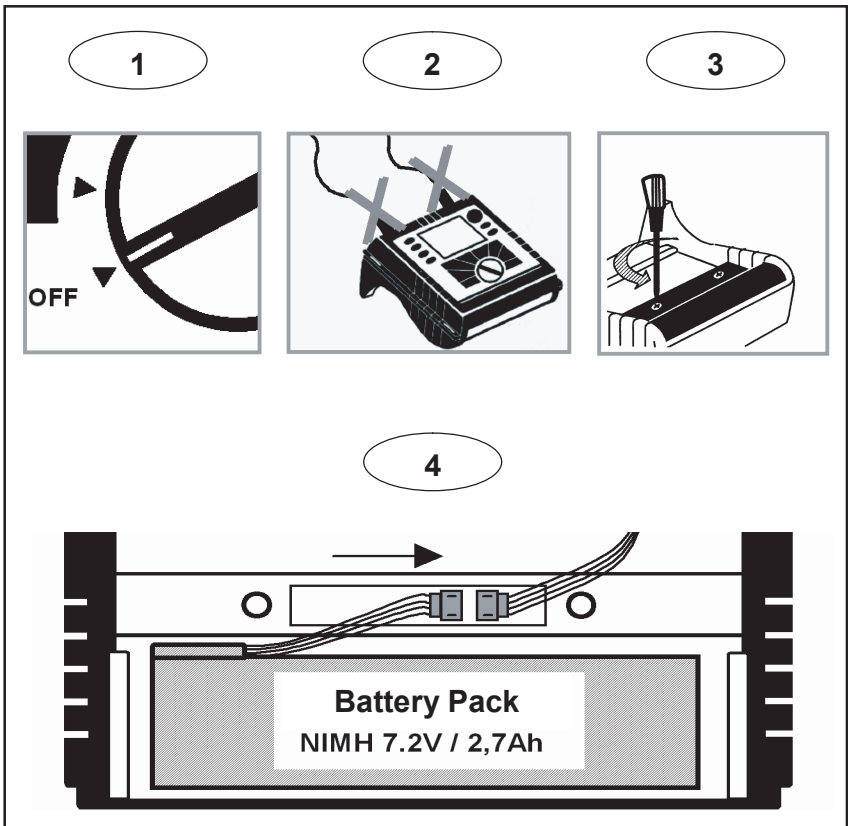

Figure 11. Replacing the Battery Pack

edx038.eps

Note

If you replace the battery please use original spare parts only – see section “Standard and Optional Accessories”.

Maintenance

If the Logger is used appropriately it does not require special maintenance or repair. If the Logger gets dirty wipe it off carefully with a damp cloth (without cleaning agents). Maintenance work may be executed only by trained and qualified personnel. This work may only be done at a company related service center within the guarantee period. See www.fluke.com for locations and contact information of Fluke Service Centers worldwide.

Calibration

As an additional service we offer the regular examination and calibration of your Logger.

Storage

If the Logger is stored for longer time or is not in use for longer time, you should charge the battery at least once every six months.

Measurement Theory

The following formulas are the basics of the measuring values:

Voltage and current measurement

$$V_{RMS} = \sqrt{\frac{1}{T} \int v^2 dt} \quad \text{RMS value of voltages}$$

$$I_{RMS} = \sqrt{\frac{1}{T} \int i^2 dt} \quad \text{RMS value of currents}$$

$$I_N = I_1 + I_2 + I_3 \quad \text{RMS value of neutral-conductor current}$$

Neutral is calculated when not measured, i.e., no 4-phase Flexi set is connected.

Waveform

The angle given in the waveform function is based on the following formula.

$$\varphi = \arctan \left[\frac{P_1}{\sqrt{P_1^2 + Q_1^2}} \right] \quad \text{Angle between}$$

Q_1 reactive power of first harmonic

P_1 active power of first harmonic

Power Measurements

$$P = \sum_{k=1}^{40} V_k \times I_k \times \cos(\varphi_k) \quad \text{active power (200 ms average values)}$$

V_k, I_k, φ_k values of harmonics

$$P_M = \frac{1}{M} \sum_{i=1}^M P_i \quad \text{active power over average interval}$$

P_i to single 200 ms values

M to number of values

$$P_{tot} = P_1 + P_2 + P_3$$

total active power

$$P_{tot} = P_1 + P_2 + P_3$$

total active power Blondel (Aron)

$$Q = \sum_{k=1}^{40} V_k \times I_k \times \sin(\varphi_k) \quad \text{reactive power (200 ms average values)}$$

V_k, I_k, φ_k values of harmonics

$$Q = \frac{1}{M} \sum_{i=1}^M Q_i \quad \text{reactive power over average time}$$

$$S = V \times I \quad \text{apparent power}$$

$$PF = \lambda = \frac{P}{S} \quad \text{power factor}$$

$$D = \sqrt{S^2 - P^2 - Q^2} \quad \text{distortion power}$$

$$\cos \varphi = \frac{P_1}{\sqrt{P_1^2 + Q_1^2}} \quad \text{cosine } \cos \varphi$$

Note

The distortion power is > zero if the waveform of current is different from the voltage waveform.

Total Harmonic Distortion

$$THD = \frac{\sqrt{\sum_{h=2}^{40} (V_h)^2}}{V_1} \times 100\% \quad \text{Total Harmonic Distortion}$$

V1 to RMS of the fundamental

Vh to RMS of the h-th harmonic

Technical Specifications

General Information

| | |
|------------------------------|--|
| Display: | ¼ VGA Graphic Color transmissive displays 320 x 240 Pixel with additional background lighting and adjustable contrast, text and graphics in color. |
| Quality: | Developed, designed and manufactured according to DIN ISO 9001 |
| Memory: | 4 MB Flash memory, from this 3.5 MB for measuring data; |
| Interface: | RS 232 SUB-D socket; 115.2 kBaud, 8 data bits, no parity, 1 stop bit, firmware updates are possible with the RS 232 interface (9-pole extension cable) |
| Sample rate: | 10.24 kHz |
| Line frequency: | 50 Hz or 60 Hz, user-selectable, with automatic synchronization |
| Power supply: | NiMH battery-pack, with ac adapter (15 V to 20 V / 0.8 A) |
| Operation time with battery: | Typical > 24 h without backlight > 12 h with backlight |
| Dimensions: | 240 x 180 x 110 mm (6.1 x 4.6 x 2.8 in) |
| Weight: | 1.7 kg (3.75 lb), including battery |

Temperature ranges

| | |
|------------------------------|------------------|
| Working temperature range: | -10 °C to +50 °C |
| Storage temperature range: | -20 °C to +60 °C |
| Operating temperature range: | 0 °C to +40 °C |
| Reference temperature range: | +23 °C ± 2 K |

Note: the above terms are defined in European Standards. To calculate the specification at any point in the working temperature range, use the temperature coefficient below.

| | |
|--------------------------|---|
| Temperature coefficient: | ± 0.1 % of the measured value per K. |
| Intrinsic error: | Refers to reference temperature, max. deviation is guaranteed for 2 years. |
| Operating error: | Refers to operating temperature range, max. deviation is guaranteed for 2 years. |
| Climatic class: | C1 (IEC 654-1) -5 ° to +45 °C, 5 % to 95 % RH, no dew |
| Housing: | Cycloy shock and scratch proof thermoplast V0-type (non-flammable) with rubber protection holster |

EMC

| | |
|-----------|--|
| Emission: | IEC/EN 61326-1:1997 class B IEC/EN 61326-1, amendment 1: 1998 |
|-----------|--|

Safety

| | |
|-------------|---|
| Safety: | IEC 61010-1 600V CAT III, double or enforced insulation, pollution degree 2 |
| Protection: | IP65; EN60529 (refers only to the main housing without the battery compartment) |

Specifications

RMS values are measured with a 20-ms resolution.

V-RMS Wye measurement

| | |
|------------------|--|
| Measuring range: | 57 / 66 / 110 / 120 / 127 / 220 / 230 / 240 / 260 / 277 / 347 / 380 / 400 / 417 / 480 V AC |
|------------------|--|

| | |
|------------------|--|
| Intrinsic error: | $\pm(0.2$ % of measured value. + 5 digits) |
|------------------|--|

| | |
|-------------------------|--|
| Operating error: | $\pm(0.5 \% \text{ of m. v.} + 10 \text{ digit})$ |
| Resolution: | 0.1 V |
| V-RMS Delta measurement | |
| Measuring range: | 100 / 115 / 190 / 208 / 220 / 380 / 400 / 415 / 450 / 480 / 600 / 660 / 690 / 720 / 830 V AC |
| Intrinsic error: | $\pm(0.2 \% \text{ of m. v.} + 5 \text{ digit})$ |
| Operating error: | $\pm(0.5 \% \text{ of m. v.} + 10 \text{ digit})$ |
| Resolution: | 0.1 V |

A-RMS measurement

Fluke Flexi sets and current probes with voltage output are supported. All current probes must correspond to 600 V / CAT III

| | |
|-------------------------|---|
| Flexi set I_N ranges: | 15 / 150 / 3000 A RMS (at sine) |
| Current clamp ranges: | 5 / 50 / 500 mV AC |
| Resolution: | 0.01 A |
| Ranges: | |
| 150 / 3000 A | 50 mv / 500 mV output |
| | Intrinsic error: $\pm(0.5\% \text{ of m. v.} + 10 \text{ digit})$ |
| | Operating error: $\pm(1\% \text{ of m. v.} + 10 \text{ digit})$ |
| 15 A | 5 mV output |
| | Intrinsic error: $\pm(0.5\% \text{ of m. v.} + 20 \text{ digit})$ |
| | Operating error: $\pm(1\% \text{ of m. v.} + 20 \text{ digit})$ |

The errors of the current probes are not considered.

By using Fluke flexi-set:

| | |
|----------------------------|---|
| Flexi set measuring error: | $\pm(2 \% \text{ of m. v.} + 10 \text{ digit})$ |
| Position influence: | $\pm(3 \% \text{ of m. v.} + 10 \text{ digit})$ |
| CF (typical): | 2.83 |

Power measurement (P, Q, S, D)

Measuring range: see V RMS and A RMS measurement

Power errors are calculated by adding the errors of voltage and current.

Additional error due to power factor PF:

Specified error x (1-IPFI)

Maximum Range with Voltage range 830 V delta-connection and 3000 A current range is 2.490 MW

Intrinsic error: $\pm (0.7 \% \text{ of m.v.} + 15 \text{ dig})$

Resolution: 1 kW

Operating error: $\pm (1.5 \% \text{ of m.v.} + 20 \text{ dig})$

Typical Range with Voltage range 230 V Wye-connection and 150 A current range is 34.50 kW

Intrinsic error: $\pm (0.7 \% \text{ of m.v.} + 15 \text{ dig})$

Resolution: 1 W to 10 W

Operating error: $\pm (1.5 \% \text{ of m.v.} + 20 \text{ dig})$

The errors of the current sensors themselves have not been considered.

Energy Measurement (kWh, KVAh, kVARh)

Intrinsic error: $\pm (0.7 \% \text{ of m.v.} + \text{F variation error}^* + 15 \text{ dig})$

Resolution: 1 W to 10 W

Operating error: $\pm (1.5 \% \text{ of m.v.} + \text{F variation error}^* + 20 \text{ dig})$

* Frequency variation error $\pm 2 \% \text{ m.v.} + 2 * (\% \text{ maximum frequency deviation})$

PF Power Factor

Range: 0.000 to 1.000

Resolution: 0.001

Accuracy: $\pm 1 \% \text{ of full scale}$

Frequency Measurement

| | |
|------------------|---|
| Measuring range: | 46 Hz – 54 Hz and 56 Hz – 64 Hz |
| Intrinsic error: | $\pm(0.2 \% \text{ of m. v.} + 5 \text{ digit})$ |
| Operating error: | $\pm(0.5 \% \text{ of m. v.} + 10 \text{ digit})$ |
| Resolution: | 0.01 Hz |

Harmonics

| | |
|-------------------------|--|
| Measuring range: | 1 to 40 th harmonic |
| Accuracy: | |
| $V_m, I_m, THDV, THDI:$ | according IEC 1000-4-7, class B |
| $V_m, I_m, THDV, THDI:$ | according IEC 1000-4-7, class B |
| $V_m \geq 3 \% V_n$ | 5 % V |
| $V_m < 3 \% V_n$ | 0.15 % V_n |
| $I_m \geq 10 \% I_n$ | 5 % I_m |
| $I_m < 10 \% I_n$ | 0.5 % I_n |
| THDV | for THD <3 %: < 0.15 % at V_n for THD \geq 3 %: < 5 % at V_n |
| THDI | for THD <10 %: < 0.5 % at I_n for THD \geq 10 %: < 5 % at I_n |

Events

Detection of voltage dips, voltage swells and voltage interruptions with a 10-ms resolution. Measuring error of the half-period sine wave of RMS:

| | |
|------------------|---|
| Intrinsic error: | $\pm(1 \% \text{ of m. v.} + 10 \text{ digit})$ |
| Operating error: | $\pm(2 \% \text{ of m. v.} + 10 \text{ digit})$ |
| Resolution: | 0.1 V |

Unbalance

RMS errors see V-RMS specification

Phase angle errors:

1735

Users Manual

| | |
|------------------|--|
| Intrinsic error: | $\pm(0.5 \% \text{ of m. v.} + 5 \text{ digit})$ |
| Operating error: | $\pm(1 \% \text{ of m. v.} + 10 \text{ digit})$ |
| Resolution: | 0.1 ° |

Note

When using Fluke flexi-sets please make sure to position the conductor opposite to the Fluke flexi-set-lock (refer following figure).

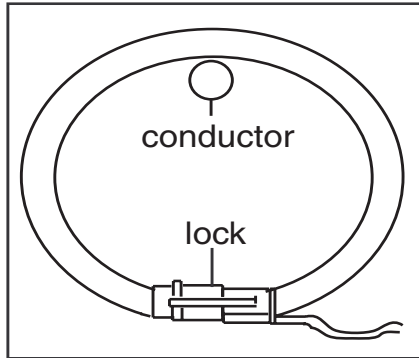

Figure 12. Flexi-probe Lock

edx039.eps]

Appendix A

Values Recorded by the Power Logger

Recorded Values

| Measurement function | Saved parameters | Description |
|---------------------------------|---|--|
| Volts/Amps/Hertz | | |
| | Voltages VL1, VL2, VL3, AVG, MIN, MAX RMS values | VoltageV1 AN Volts&Amps VOLTAGE (AVG) VoltageV1 AN Volts&Amps VOLTAGE (MAX) VoltageV1 AN Volts&Amps VOLTAGE (MIN) VoltageV2 BN Volts&Amps VOLTAGE (AVG) VoltageV2 BN Volts&Amps VOLTAGE (MAX) VoltageV2 BN Volts&Amps VOLTAGE (MIN) VoltageV3 CN Volts&Amps VOLTAGE (AVG) VoltageV3 CN Volts&Amps VOLTAGE (MAX) VoltageV3 CN Volts&Amps VOLTAGE (MIN) |

| Measurement function | Saved parameters | Description |
|----------------------|---|--|
| | <p>Currents I1, I2, I3, AVG, MIN, MAX RMS values</p> | <p>Current I1 AN Volts & Amps CURRENT (AVG)</p> <p>Current I1 AN Volts & Amps CURRENT MAX)</p> <p>Current I1 AN Volts & Amps CURRENT (MIN)</p> <p>Current I2 BN Volts & Amps CURRENT (AVG)</p> <p>Current I2 BN Volts & Amps CURRENT (MAX)</p> <p>Current I2 BN Volts & Amps CURRENT (MIN)</p> <p>Current I3 CN Volts & Amps CURRENT (AVG)</p> <p>Current I3 CN Volts & Amps CURRENT (MAX)</p> <p>Current I3 CN Volts & Amps CURRENT (MIN)</p> |
| | <p>Frequency, AVG, MIN, MAX values</p> | <p>Frequency F TOTAL Volts & Amps VOLTAGE (AVG)</p> <p>Frequency F TOTAL Volts & Amps VOLTAGE (MAX)</p> <p>Frequency F TOTAL Volts & Amps VOLTAGE (MIN)</p> |
| <p>Harmonics</p> | | |
| | <p>Voltages VL1, VL2, VL3, AVG, MIN, MAX RMS values</p> | <p>VoltageV1 AN Harmonic VOLTAGE (AVG)</p> <p>VoltageV1 AN Harmonic VOLTAGE (MAX)</p> <p>VoltageV1 AN Harmonic VOLTAGE</p> |

| Measurement function | Saved parameters | Description |
|----------------------|---|--|
| | | (MIN) VoltageV2 BN Harmonic VOLTAGE (AVG) VoltageV2 BN Harmonic VOLTAGE (MAX) VoltageV2 BN Harmonic VOLTAGE (MIN) VoltageV3 CN Harmonic VOLTAGE (AVG) VoltageV3 CN Harmonic VOLTAGE (MAX) VoltageV3 CN Harmonic VOLTAGE (MIN) |
| | Currents I1, I2, I3, In AVG, MIN, MAX RMS values | Current I1 AN Harmonic CURRENT (AVG) Current I1 AN Harmonic CURRENT (MAX) Current I1 AN Harmonic CURRENT (MIN) Current I2 BN Harmonic CURRENT (AVG) Current I2 BN Harmonic CURRENT (MAX) Current I2 BN Harmonic CURRENT (MIN) Current I3 CN Harmonic CURRENT (AVG) Current I3 CN Harmonic CURRENT (MAX) Current I3 CN Harmonic CURRENT (MIN) |

| Measurement function | Saved parameters | Description |
|----------------------|--|--|
| | | Current IN NG Harmonic CURRENT (AVG) Current IN NG Harmonic CURRENT (MAX) Current IN NG Harmonic CURRENT (MIN) |
| | THD I L1, L2, L3, In, AVG, MIN, MAX RMS values | THD I1 AN Harmonic CURRENT (AVG) THD I1 AN Harmonic CURRENT (MAX) THD I1 AN Harmonic CURRENT (MIN) THD I2 BN Harmonic CURRENT (AVG) THD I2 BN Harmonic CURRENT (MAX) THD I2 BN Harmonic CURRENT (MIN) THD I3 CN Harmonic CURRENT (AVG) THD I3 CN Harmonic CURRENT (MAX) THD I3 CN Harmonic CURRENT (MIN) THD I _n NG Harmonic CURRENT (AVG) THD I _n NG Harmonic CURRENT (MAX) THD I _n NG Harmonic CURRENT (MIN) |
| | THD V L1, L2, L3, AVG, MIN, MAX RMS values | THD V1 AN Harmonic VOLTAGE (AVG) THD V1 AN Harmonic VOLTAGE (MAX) THD V1 AN Harmonic VOLTAGE (MIN) THD V2 BN Harmonic VOLTAGE (AVG) THD V2 BN Harmonic VOLTAGE (MAX) THD V2 BN Harmonic VOLTAGE (MIN) THD V3 CN Harmonic VOLTAGE (AVG) THD V3 CN Harmonic VOLTAGE (MAX) |

| Measurement function | Saved parameters | Description |
|----------------------|---|---|
| | | THD V3 CN Harmonic VOLTAGE (MIN) |
| | Values of uneven harmonics from the 1 st - 25 th order for V1, V2, V3, I1, I2, I3 ,In, AVG, MIN, MAX RMS values | |
| | Frequency, AVG, MIN, MAX values | Frequency F TOTAL Harmonic VOLTAGE (AVG) Frequency F TOTAL Harmonic VOLTAGE (MAX) Frequency F TOTAL Harmonic VOLTAGE (MIN) |
| W Power | | |
| | Currents I1, I2, I3,In AVG, MIN, MAX RMS values | Current I1 AN Power CURRENT (AVG) Current I1 AN Power CURRENT (MAX) Current I1 AN Power CURRENT (MIN) Current I2 BN Power CURRENT (AVG) Current I2 BN Power CURRENT (MAX) Current I2 BN Power CURRENT (MIN) Current I3 CN Power CURRENT (AVG) Current I3 CN Power CURRENT (MAX) Current I3 CN Power CURRENT (MIN) Current I _n NG Power CURRENT (AVG) Current I _n NG Power CURRENT (MAX) |

| Measurement function | Saved parameters | Description |
|----------------------|---|--|
| | | Current I _n NG Power CURRENT (MIN) |
| | Real powers P1, P2, P3, AVG, MIN, MAX values | Real Power P1 AN Power POWER (AVG) Real Power P1 AN Power POWER (MAX) Real Power P1 AN Power POWER (MIN) Real Power P2 BN Power POWER (AVG) Real Power P2 BN Power POWER (MAX) Real Power P2 BN Power POWER (MIN) Real Power P3 CN Power POWER (AVG) Real Power P3 CN Power POWER (MAX) Real Power P3 CN Power POWER (MIN) |
| | Voltages VL1, VL2, VL3, AVG, MIN, MAX RMS | VoltageVU1 AN Power VOLTAGE (AVG) VoltageV1 AN Power VOLTAGE (MAX) VoltageV1 AN Power VOLTAGE (MIN) VoltageV2 BN Power VOLTAGE (AVG) |

| Measurement function | Saved parameters | Description |
|----------------------|--|--|
| | values | VoltageV2 BN Power VOLTAGE (MAX) VoltageV2 BN Power VOLTAGE (MIN) VoltageV3 CN Power VOLTAGE (AVG) VoltageV3 CN Power VOLTAGE (MAX) VoltageV3 CN Power VOLTAGE (MIN) |
| | Apparent powers S1, S2, S3, AVG, MIN, MAX values | Apparent Power S1 AN Power POWER (AVG) Apparent Power S1 AN Power POWER (MAX) Apparent Power S1 AN Power POWER (MIN) Apparent Power S2 BN Power POWER (AVG) Apparent Power S2 BN Power POWER (MAX) Apparent Power S2 BN Power POWER (MIN) Apparent Power S3 CN Power POWER (AVG) Apparent Power S3 CN Power POWER (MAX) Apparent Power S3 CN Power POWER (MIN) |
| | Reactive powers Q1, Q2, Q3, AVG, MIN, MAX values | Reactive Power Q1 AN Power POWER (AVG) Reactive Power Q1 AN Power POWER (MAX) Reactive Power Q1 AN Power POWER (MIN) Reactive Power Q2 BN Power |

| Measurement function | Saved parameters | Description |
|----------------------|--|---|
| | | POWER (AVG) Reactive Power Q2 BN Power POWER (MAX) Reactive Power Q2 BN Power POWER (MIN) Reactive Power Q3 CN Power POWER (AVG) Reactive Power Q3 CN Power POWER (MAX) Reactive Power Q3 CN Power POWER (MIN) |
| | Distortion powers D1, D2, D3, AVG, MIN, MAX values | Distortion Power D1 AN Power POWER (AVG) Distortion Power D1 AN Power POWER (MAX) Distortion Power D1 AN Power POWER (MIN) Distortion Power D2 BN Power POWER (AVG) Distortion Power D2 BN Power POWER (MAX) Distortion Power D2 BN Power POWER (MIN) Distortion Power D3 CN Power POWER (AVG) Distortion Power D3 CN Power POWER (MAX) Distortion Power D3 CN Power POWER (MIN) |
| | Frequency, AVG, MIN, | Frequency F TOTAL Power |

| Measurement function | Saved parameters | Description |
|----------------------|---|--|
| | MAX values | VOLTAGE (AVG) Frequency F TOTAL Power VOLTAGE (MAX) Frequency F TOTAL Power VOLTAGE (MIN) |
| | Cosφ L1,L2, L3 | Cos PHI 1 AN Power POWER (AVG) Cos PHI 1 AN Power POWER (MAX) Cos PHI 1 AN Power POWER (MIN) Cos PHI 2 BN Power POWER (AVG) Cos PHI 2 BN Power POWER (MAX) Cos PHI 2 BN Power POWER (MIN) Cos PHI 3 CN Power POWER (AVG) Cos PHI 3 CN Power POWER (MAX) Cos PHI 3 CN Power POWER (MIN) |
| | Power factors PF1, PF2, PF3, AVG, MIN, MAX values | Power Factor PF1 AN Power POWER (AVG) Power Factor PF1 AN Power POWER (MAX) Power Factor PF1 AN Power POWER (MIN) Power Factor PF2 BN Power POWER (AVG) Power Factor PF2 BN Power POWER (MAX) Power Factor PF2 BN Power POWER (MIN) Power Factor PF3 CN Power POWER (AVG) Power Factor PF3 CN Power |

| Measurement function | Saved parameters | Description |
|----------------------|--|---|
| | | POWER (MAX) Power Factor PF3 CN Power POWER (MIN) |
| | Reactive energy EQ1, EQ2, EQ3 Averages only | Reactive Energy EQ1 AN Power ENERGY (AVG) Reactive Energy EQ2 BN Power ENERGY (AVG) Reactive Energy EQ3 CN Power ENERGY (AVG) |
| | Real energy EP1, EP2, EP3 Averages only | Real Energy EP1 AN Power ENERGY (AVG) Real Energy EP2 BN Power ENERGY (AVG) Real Energy EP3 CN Power ENERGY (AVG) |
| Events | | |
| | Voltages VL1, VL2, VL3, MIN, MAX of 10-ms RMS values | DIP-Phase CN VALUELOG VOLTAGE MIN VOLTS RMS DIP-Phase CN VALUELOG VOLTAGE MAX VOLTS RMS BAND-Phase CN VALUELOG VOLTAGE MIN VOLTS RMS BAND-Phase CN VALUELOG VOLTAGE MAX VOLTS RMS INTER-Phase AN VALUELOG VOLTAGE MIN VOLTS RMS INTER-Phase AN VALUELOG VOLTAGE MAX VOLTS RMS SWELL-Phase BN VALUELOG VOLTAGE MIN VOLTS RMS |

| Measurement function | Saved parameters | Description |
|-----------------------------|----------------------------|--|
| | | SWELL-Phase BN VALUELOG VOLTAGE MAX VOLTS RMS |
| | Number of events per phase | |

